



ES8500

User Manual



Contents

Introduction

<i>Introduction</i>	2
<i>Specifications</i>	3
<i>Identifying Parts</i>	4

Installation

<i>Installation</i>	7
---------------------	---

Operation

<i>OP Panel</i>	8
<i>Paper Loading</i>	10
<i>Fold Type Setting</i>	12
<i>Understanding Folding Mechanism</i>	13
<i>Operation</i>	20
<i>Functions</i>	21

Maintenance

<i>Paper Jam</i>	24
<i>Trouble Shooting</i>	25
<i>Cleaning</i>	26

Introduction

Welcome!

Thank you very much for selecting our product!

This manual is prepared to provide you with guidelines on how to properly operate and maintain the ES8500. Please read this user manual before operating in order to prevent unexpected malfunction or damage. Please refer to the manual carefully and follow the instruction.

Copyright

Any of the contents should not be copied, re-printed or translated by other languages without Paitec USA approval.

Safety Precautions



Caution: Serious bodily injury or mechanical damage may result from insufficient attention to or incorrect compliance with warning messages using this symbol.

- Do not attempt to disassemble or reorganize the machine. It may cause an electric shock or mechanical problem.
- Quickly disconnect the power if liquid or a foreign object enter the inside of the machine.
- Do not enter metal or inflammable material into AC Inlet.
- Please contact local dealer when you relocate the machine.
- This manual is subject to be revised without notice for product improvement.
- Do not install the machine on the place as below.
 - Near window or places exposed to direct sunlight.
 - Where vibration is detected.
 - Sudden temperature changes or poorly ventilated areas.
 - Places exposed to hot or cold air directly. (not office circumstance)
 - Not solid enough or weak floor.



Specifications

Features

- ES8500 is a mid-volume pressure sealer. It features processing speed up to 9,000 forms per hour, perfect sealing quality with 2 metal seal rollers, with a monthly duty cycle of up to 130,000 forms per month.
- ES8500 is Dual-Purpose(Stand alone or Optional In-Line kit), works equally well as a stand-alone or in-line with laser printers a rear-exit paper path.

Specifications

Specifications	
Form Size	A4 / Legal / Letter
Paper Weight	22#-28#
Speed	Max 9,000 forms per hour
Fold Setting	Manual
Fold Type	Z, C, V, EZ
Double Feeding Detect	Available by DFD sensor
Stacker	Built-in 150 forms catch tray or Optional Conveyor
Duty	130,000 / month

Identifying Parts

Main Body

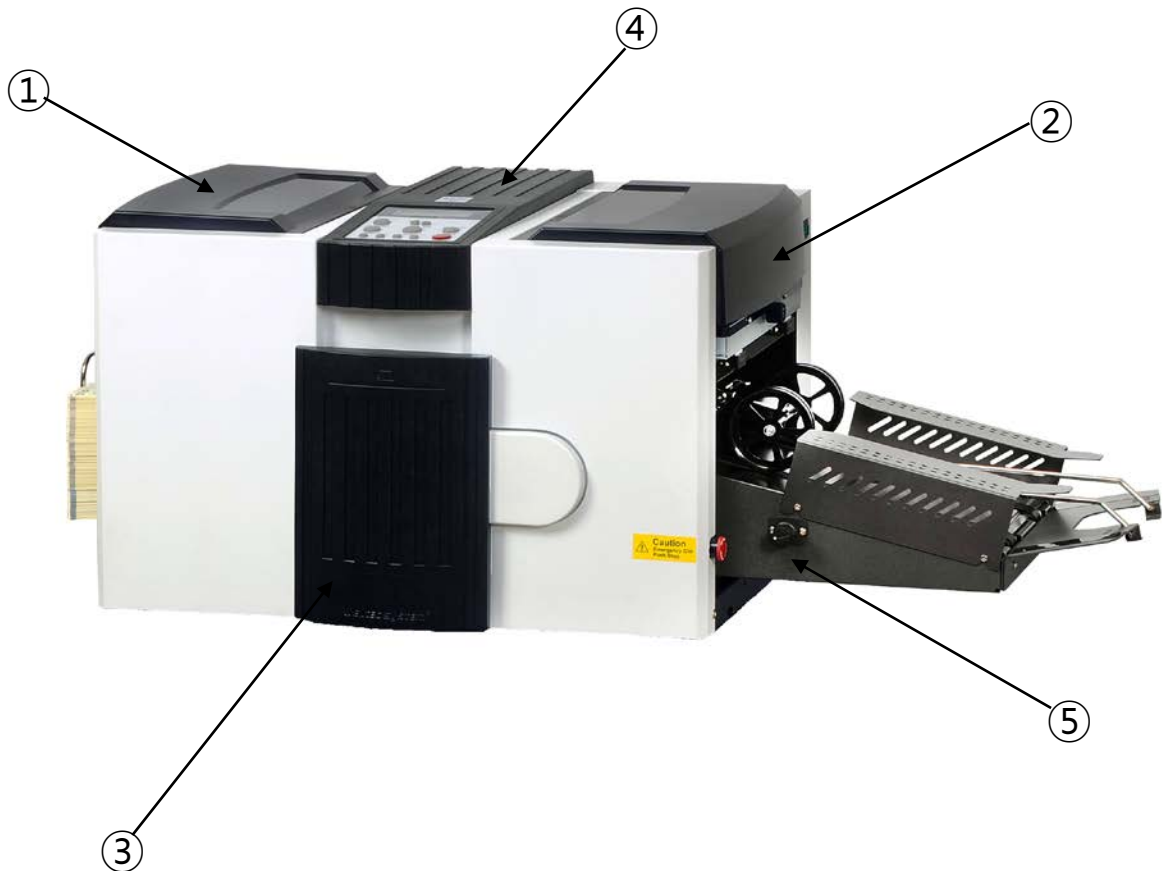

- ① Feeding Unit Safety Cover
- ② Upper Fold Cassette Safety Cover
- ③ Lower Fold Cassette Door
- ④ OP Panel
- ⑤ Conveyor (optional)

Identifying Parts

Large Capacity Feed Table

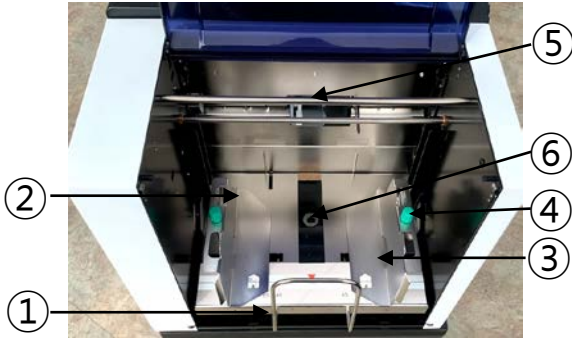

- ① Feed Assist Hanger
- ② Feed Guide (Left)
- ③ Feed Guide (Right)
- ④ Locking Knob
- ⑤ In-feed Roller
- ⑥ Paper Detection Sensor

Lower Fold Cassette

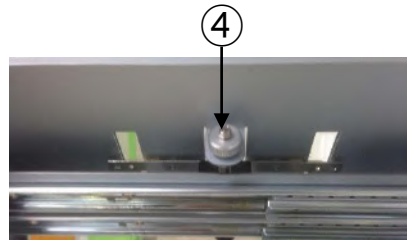
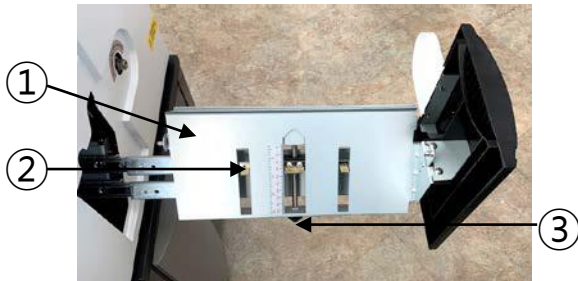

- ① Lower Cassette
- ② Stopper
- ③ Stopper Adjustment Knob
- ④ Stopper Locking Knob

Upper Fold Cassette

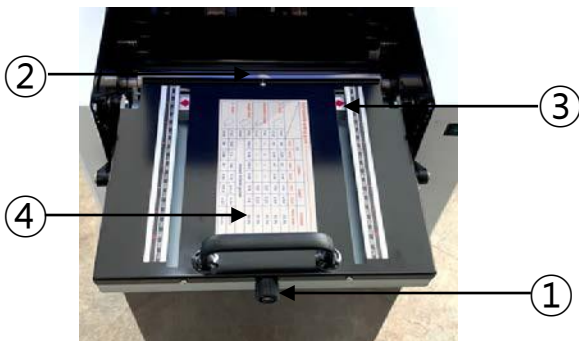

- ① Stopper Adjustment Knob
- ② Stopper Locking Knob
- ③ Fold Position Marker
- ④ Fold Position Information

Identifying Parts

Exit Side



- ① Power Switch
- ② Main Power Socket
- ③ Conveyor Power Socket
- ④ 110~230V Switching Switch
- ⑤ Emergency Switch



Be careful when you change the 110~230V Switching Switch. If the voltage selection is not correct, it may cause a damage on the machine.

Installation

Installation Environment

1. Input power : 100V / 230V (selected by 110~230V Switching Switch)
2. Machine size(mm) : 24" x 18" x 16" (without conveyor)
3. Machine weight : 115 Lbs.
 - Weight of a product is heavy, please use appropriate table to support it.
 - Please use grounded power cable.

Unpacking

Please check if all of the following parts are included in the box.

- Main body, Power Cord, User's Manual, Jam Removal tool.

Removing Safety Tape and Styrofoam Location

Please remove all safety tapes and Styrofoam before operation.

Power Connection

Please refer to the label for electric information which is located at the back side of the machine. When the power cable is properly connected, please switch the machine on and check whether 'Ready' sign is shown on the display panel.

If not, please contact your local dealer for service.

OP Panel

1 OP Panel Display

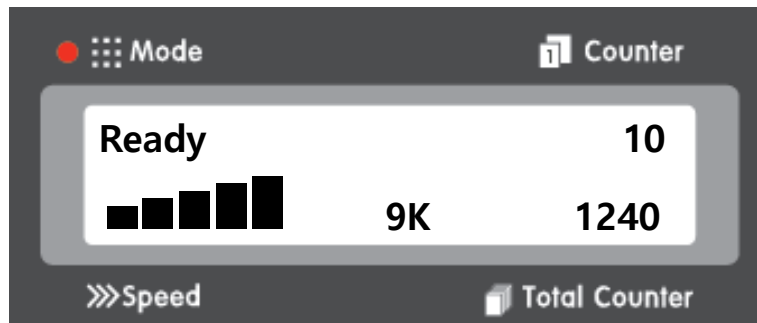

- ① Mode: Machine setting and working condition.
- ② Speed: Variable speed (adjustable, 6K / 7K / 8K / 9K)
- ③ Counter: Counter of current job.
- ④ Total Counter: Counter of total operation.

OP Panel

2 OP Panel Functions

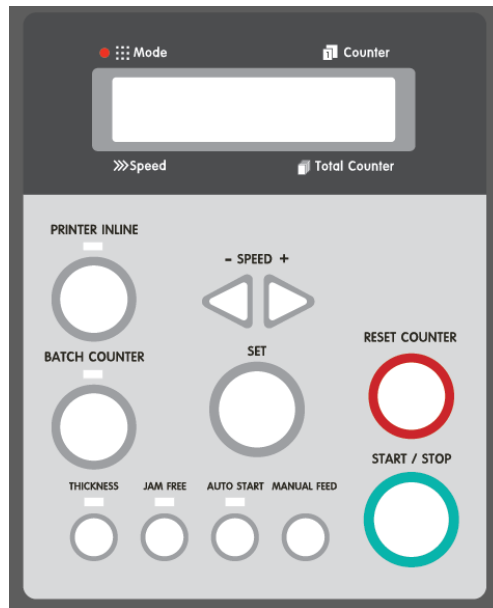

- ① Start / Stop: Start & stop the machine. If you press during setting, it returns to the prior condition
*Press the button while Feed Table is moving up & down, the Feed Table stops at current position.
- ② Set: Sets and stores the selected function.
- ③ Printer Inline: Activate / deactivate Inline function.
*To use Inline operation, you need inline kit (optional) & compatible printer.
- ④ Batch Counter: Enables you to set the number of forms that you wish to process.
- ⑤ Speed (◀▶): Selects yes/no or increase/decrease numerical value when you set.
- ⑥ Reset Counter: Clears the count on the display.
- ⑦ Thickness: Protects the double or multiple feeding.
- ⑧ Jam Free: Reverse rollers for manually remove of paper jam at folding roller or press roller.
*Also aggregates conveyor output
- ⑨ Auto Start: Re-starts the process after selected time when the job reaches preset count.
- ⑩ Manual Feed: Use for single-sheet operation manually.

Paper Loading

Paper Size

ES8500 handles any form that is larger or smaller than the following forms.

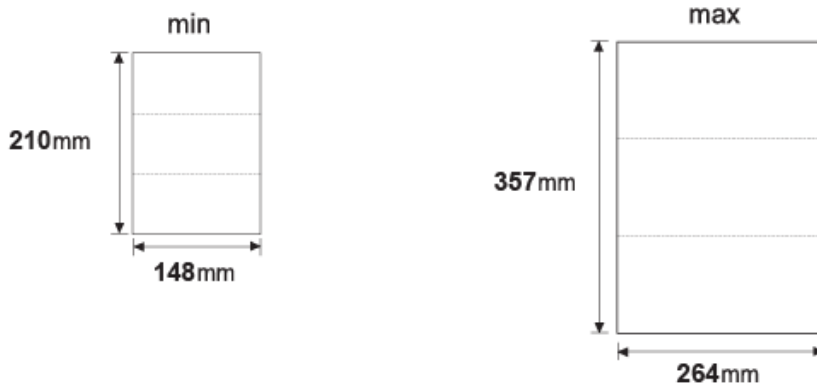

Paper Feeding

1. Before loading the forms onto the machine, please make sure all forms are aligned and fanned. Please refer to the images below.

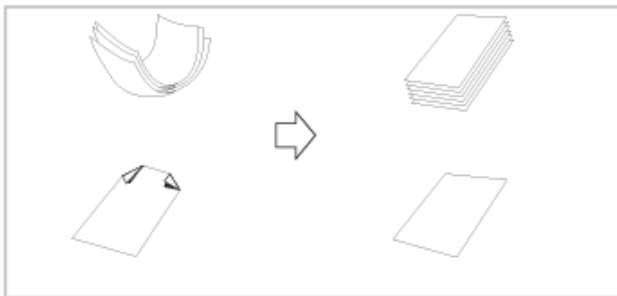

Good



Bad

If the condition of forms are not good as the picture above (Bad), place appropriate quantity of forms, unless forms will be jammed.

Paper Loading

2. Open the safety cover of the feeding unit. The tray will go down.
3. When the feed tray is down to the bottom, loosen the green knobs on both paper guides.
4. Load the aligned forms onto the feed tray and adjust the paper guides so they are gently covering the sides of the stacked forms.



5. Tighten back the green knobs on both paper guides.
6. Once loading is complete, please close the safety cover. The feed tray will go up.



Poor quality forms may cause frequent paper jams.



Make sure the paper guides are not set narrower or wider than the width of the paper.

Fold Type Setting

Setting of Paper and Folding Type

The following instruction shows how to set 8 ½" x 11" size Z-Fold.

(Note: Please be noted that the position marker doesn't guarantee 100% positioning)

1. Lower Cassette Fold Setting - 93mm



- 1) Unlock the fold position of the lower cassette by turning the stopper locking knob counter clockwise.
- 2) Adjust the stopper so the surface of the rubber is lined up at 93mm.
- 3) Lock the stopper by holding the stopper adjustment knob and turning the stopper locking knob clockwise.

2. Upper Cassette Fold Setting - 93mm



- 1) Unlock the fold position of the upper cassette by turning the stopper locking knob counter clockwise.
- 2) Adjust the stopper so the red marker is lined up at 93mm..
- 3) Lock the stopper by holding the stopper adjustment knob and turning the stopper locking knob clockwise.



Understanding Folding Mechanism

It is important to understand how ES8500 folds paper in order to accurately set the fold setting. Please read the following information carefully to fully understand the folding mechanism of ES8500.

1. The folding unit is composed of rollers, cassettes and stoppers.

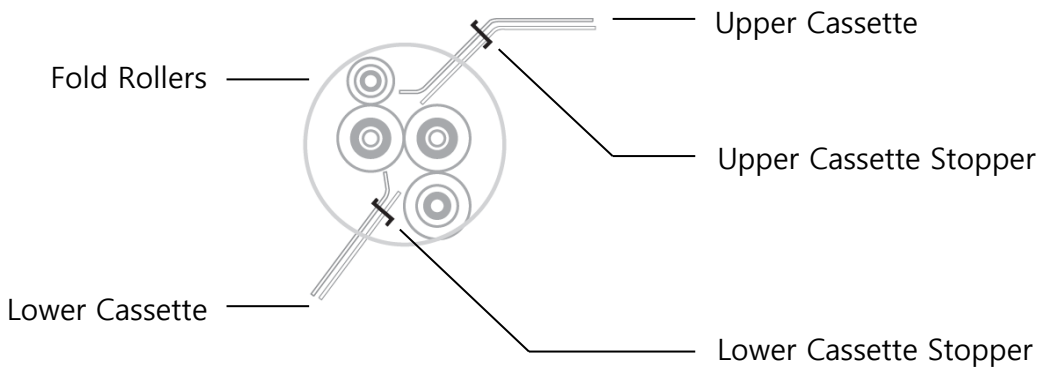

2. The form enters in between the two front fold rollers.

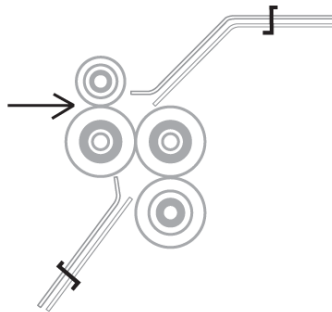

3. The form hits the upper cassette stopper and buckles in the middle. Then the folded portion enters in between the middle two rollers.

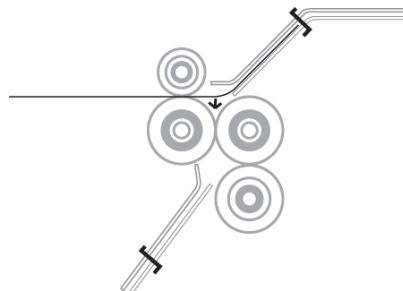

Understanding Folding Mechanism

4. The form hits the lower cassette stopper and forms a buckle. The folded form then enters in between the two outer rollers.

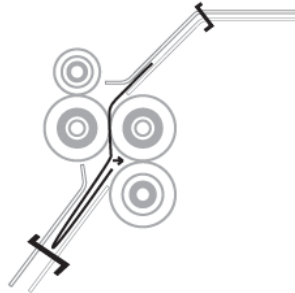

5. The folded form then exits the fold rollers and then are sent to the press unit.

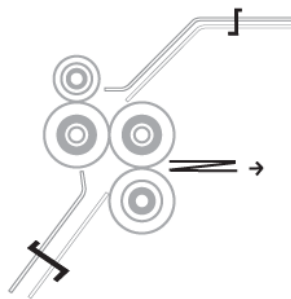

Understanding Folding Mechanism

Z-Fold Setting

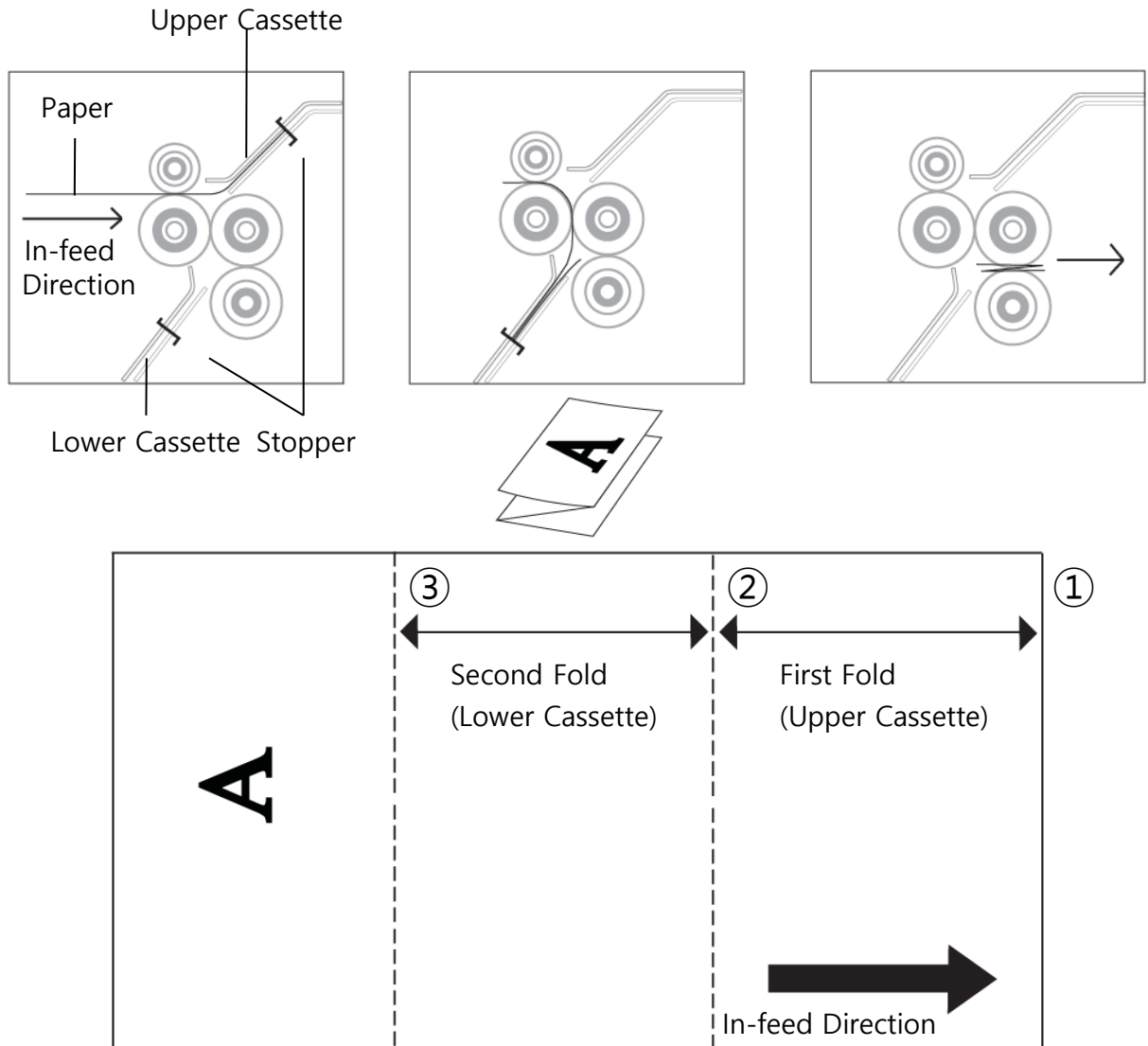

When setting a Z-Fold, please read the following steps.

1. Measure the length from line 1 to line 2 of the form as indicated in the image above. That measurement is the fold setting for the first (upper fold cassette) fold.
2. Measure the length from line 2 to line 3 of the form as indicated in the image above. That measurement is the fold setting for the second (lower fold cassette) fold.

Understanding Folding Mechanism

V-Fold Setting

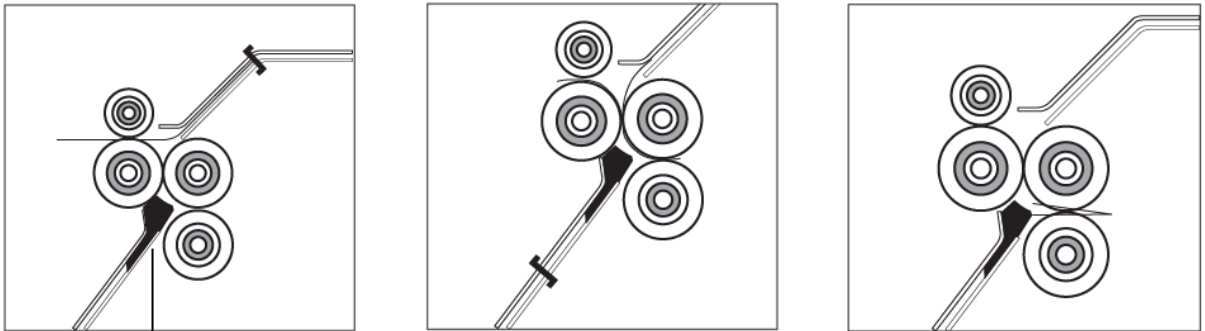

V-fold Guide

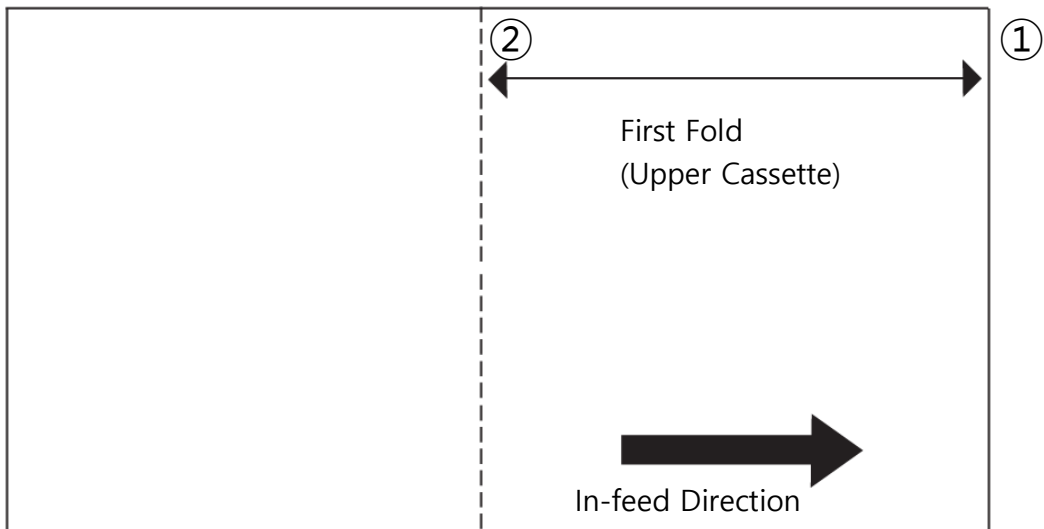

When setting a V-Fold, please read the following steps.

1. Measure the length from line 1 to line 2 of the form as indicated in the image above. That measurement is the fold setting for the first (upper cassette) fold.
2. Make sure the V-fold guide is placed at the entrance of the lower cassette.



Understanding Folding Mechanism

C-Fold Setting

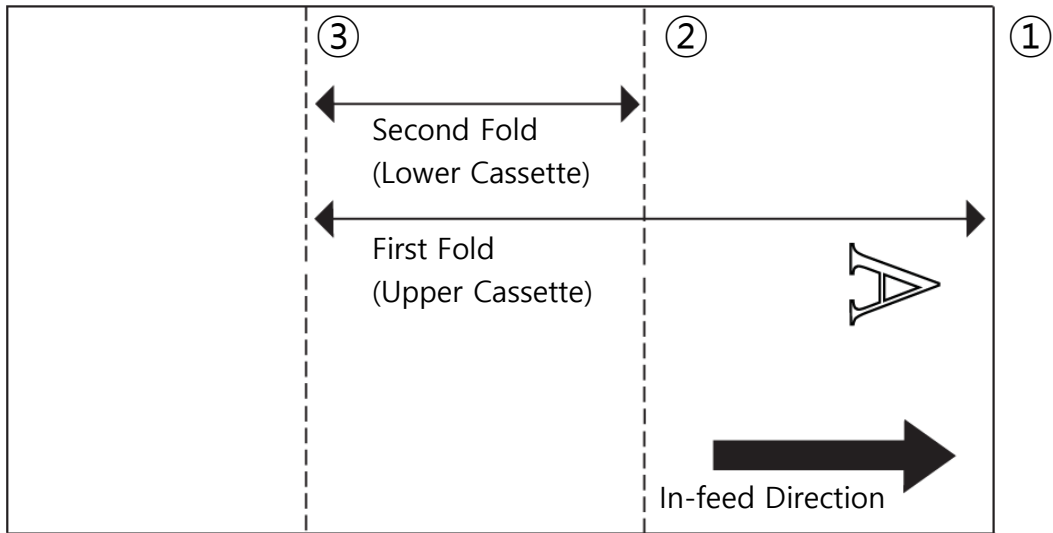
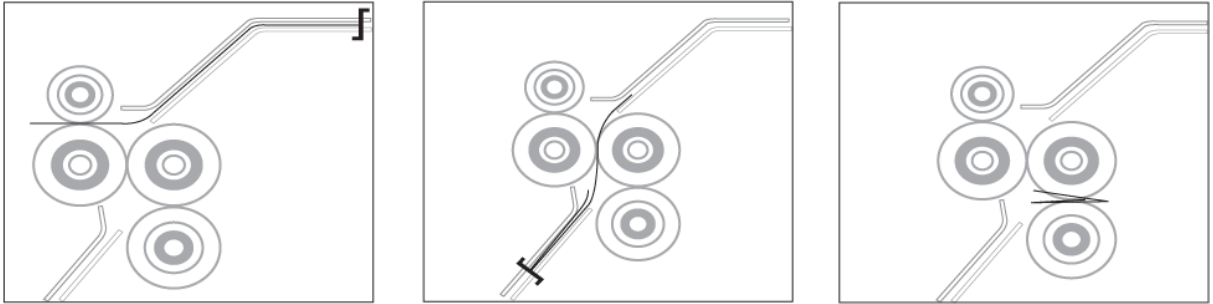

When setting a C-Fold, please read the following steps.

1. Measure the length from line 1 to line 3 of the form as indicated in the image above. That measurement is the fold setting for the first (upper cassette) fold.
2. Measure the length from line 3 to line 2 of the form as indicated in the image above. That measurement is the fold setting for the second (lower cassette) fold.

Understanding Folding Mechanism

Double-Fold Setting

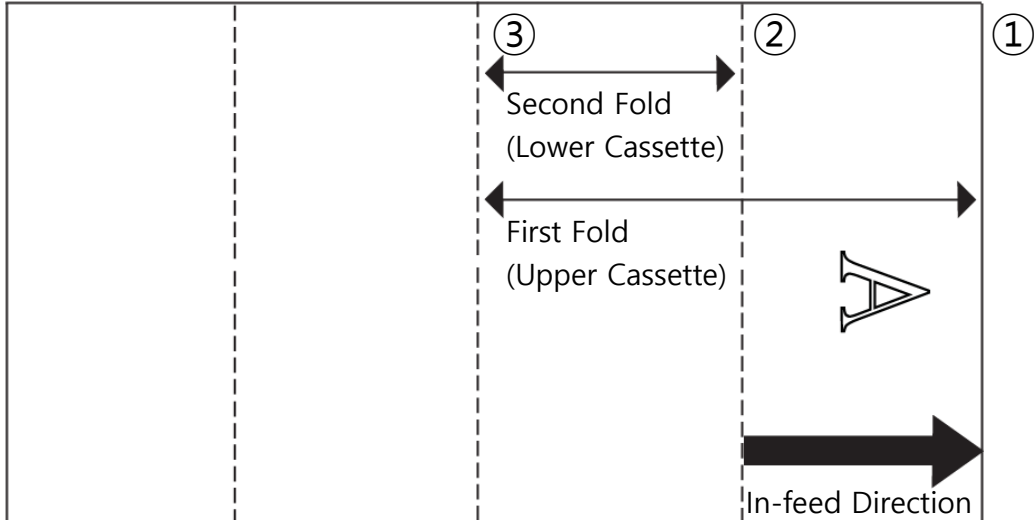
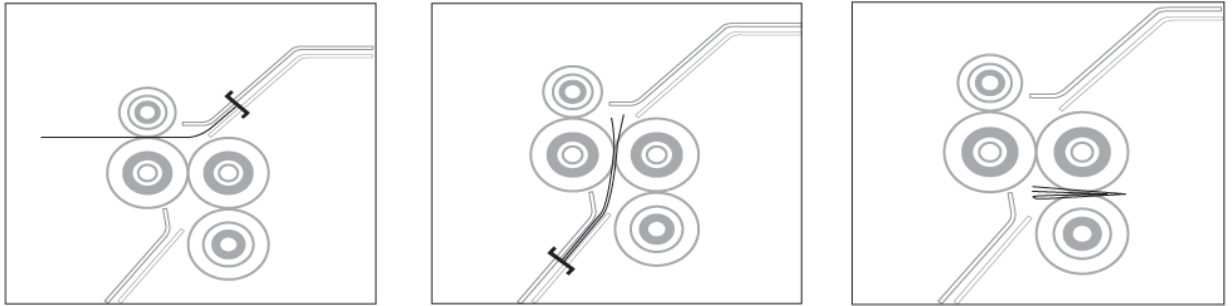

When setting a Double-Fold, please read the following steps.

1. Measure the length from line 1 to line 3 of the form as indicated in the image above. That measurement is the fold setting for the first (upper cassette) fold.
2. Measure the length from line 3 to line 2 of the form as indicated in the image above. That measurement is the fold setting for the second (lower cassette) fold.



Understanding Folding Mechanism

Window-Fold Setting

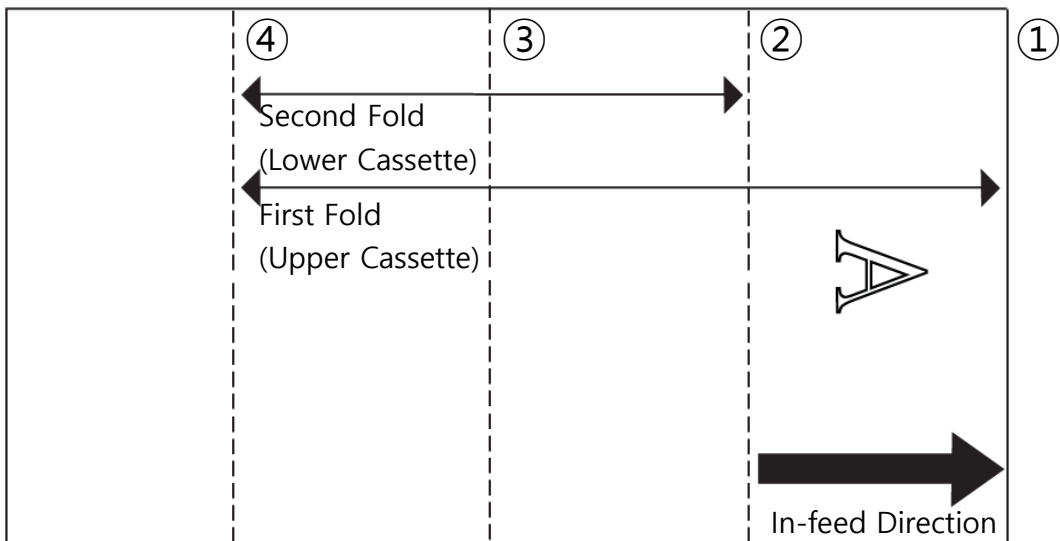
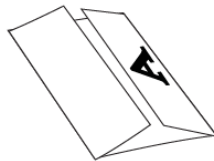
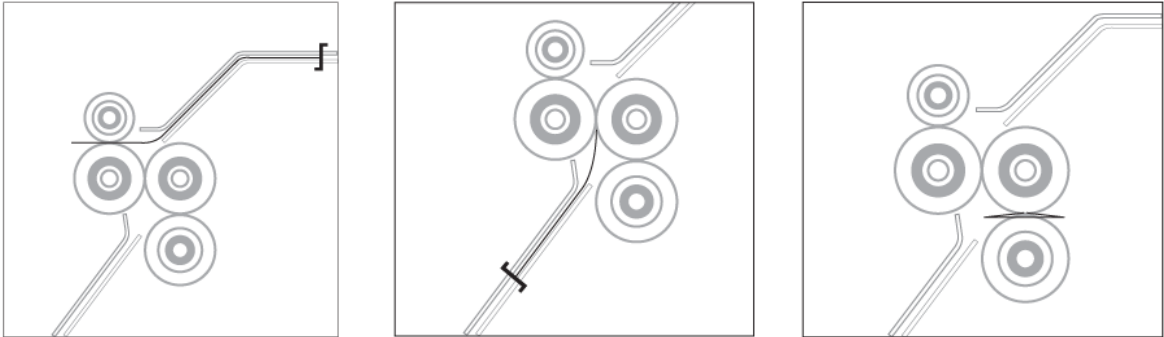

When setting a Window-Fold, please read the following steps.

1. Measure the length from line 1 to line 4 of the form as indicated in the image above. That measurement is the fold setting for the first (upper cassette) fold.
2. Measure the length from line 4 to line 2 of the form as indicated in the image above. That measurement is the fold setting for the second (lower cassette) fold.

Operation

1

Load the paper on the Feed Table (LCT).

2

Adjust the fold position of the fold cassettes (UCA / LCA) as your desire fold type.

3

Press the Thickness button on the OP Panel to detect the thickness of the paper.

- ① The ES8500 has a light sensor to detect paper thickness & prevent double feeding.
When you press the Thickness button, a sheet of paper is fed and automatically detects the paper thickness.
- ② When the double detection function is activated, the Thickness lamp is turned on
Pressing the button again will turn off the lamp and double detection will be disabled.

4

Press Start / Stop button for operation

- ① Operation will continue to run until finishing all of the paper loaded on the LCT.
(when Batch Count / Auto Start function is activated, it depends on the amount of count setup)
- ② Press Start / Stop while operation, the machine stops.



If an emergency occurs during operation, press the emergency switch on the front of the unit to stop the machine.

Functions

1

Batch Count

You can set the Batch Count of jobs to be done. For example, if you set the count on 100, machine will stop operating when the job reaches 100. Press Start/Stop button again, machine will start to finish another 100.

- ① Press Batch Count button and the LED will light on
- ② Select job volume by using ◀▶ button.
 - * Press the button on by one, count will change by 1 and if you press for more than one second, the count will change by 10/second.
 - * Press Batch Count button, the count will change 50~100.
- ③ Press Set button and check the number displayed on the panel.
 - * You can set the counter up to 500 sheets.

2

Auto Start

Auto Start function is to separate the job as volume setting with time interval between Jobs. The machine will automatically rework after the set number of work.

- ① Set the Batch Count first. Auto Start is only available when Batch Count is activated.
- ② After pressing Auto Start, "Time Interval" will be shown on the OP. Set the interval time with ◀▶ buttons.
- ③ Press Set to save the value. (Max 99 seconds)
- ④ After the job is done as Batch Count setting, taking Time Interval as setting & rework automatically.
- ⑤ If you turn off and on the machine, you have to set the function again.

Functions

3 Thickness

The Thickness function detects the thickness of the paper through the light sensor to prevent serious paper jams due to double or multiple feeding.

- ① Press the Thickness button, 1 sheet is fed to detect the thickness of the paper.
- ② When the double detection function is activated, the Thickness lamp is turned on. Pressing the button again will turn off the lamp and double detection will be disabled.
- ③ When the machine is detecting double feeding while using the function, the machine will stop operating with the message "Double Feed".



Turn off and on the machine or change the paper type, be sure to reset the paper thickness by pressing the Test button.

4 Manual Feed

Manually handling single sheet job for damaged paper & small amount of work.

- ① Holding down the Manual Feed button on OP Panel & locate the paper on paper exit.
- ② Press Manual Feed (Silver) button. The paper enters to press roller for sealing and ejected.
- ③ Keep holding down the Manual Feed button on OP panel until operation is done.



Be careful not to get your hands caught in the press roller inside the Machine while using Manual Feed Function.

Functions

5 Jam Free

In case the paper is jammed at folding roller or press roller, machine will stop with error message. Then, press Jam Free button, the fold and seal rollers will turn in reverses so that you can manually remove the paper jam.



The Jam Free feature does not resolve all paper jams. In the event of a serious paper jam, use Jam Removal Handle to the Jam Removal Hole to remove the paper jam.

※ To clear the paper jam manually, open the LCA door & rotate the Jam Removal Tool counter clockwise to remove paper jam.

Do not try to force the paper jam forward to the Exit side.

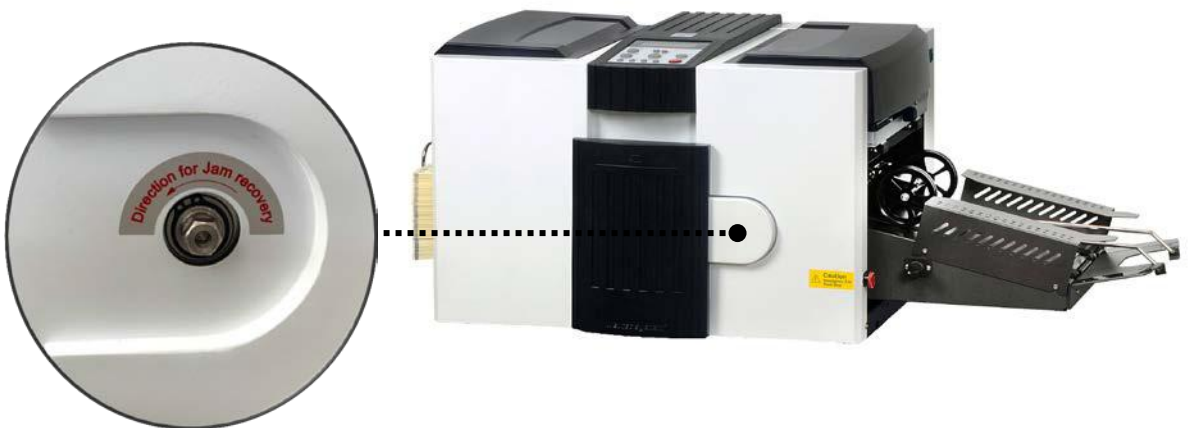

Be sure to remove the handle before operating the machine.

Paper Jam

1 Upper Fold Cassette (UCA) Paper Jam

- ① Open Safety Cover (Right)
- ② Pull out the UCA & remove the paper jam.

2 Lower Fold Cassette (LCA) Paper Jam

- ① Pull out the LCA.
- ② Remove the paper jam.

3 Seal / Press Roller Paper Jam

- ① Try to remove the jam by using the Jam Free function.
- ② If the jam is not cleared by using the Jam Free function, please use the jam removal handle to manually remove the jam.



Turn off the power before jam clear.

Trouble Shooting

1

No Power

- ① Check whether the power cable is properly connected.
- ② Check the power supply.
- ③ Check the Emergency Button is pushed.

2

Incorrect Folding

- ① Check out the fold position of UCA / LCA is correct.
- ② Check the direction of paper on the LCT.

3

Power On, but No Start

- ① Check the "Mode" on the OP Display is "Ready" condition.
- ② Check out the Safety Covers (left & right) are closed.
- ③ Check out the LCA / UCA is closed.
- ④ Check out if there is a paper jam inside of the machine.

4

Frequent Double or Multiple Sheet Feeding

- ① Check the condition of Infeed Roller Set. Try to do clean them or exchange all three rollers all at once if they are worn out.
- ② Check whether the adhesive on the sealer paper is too thick or strong.
- ③ If the paper is curled or the ink does not dry out after printing, the paper may not be separated properly.
- ④ Power On or after changing the form, Press Thickness Button to re-calibration.



If the errors keep occurring, please contact the local dealer or service company.

Cleaning

1

Infeed Roller Set

The feeding rollers consist of three different rollers as Pickup / Feed / Separation Roller. If the rollers are contaminated or worn out, feeding failures might be occurred. Please clean the roller periodically. If they are worn out, replace 3 of them at once.

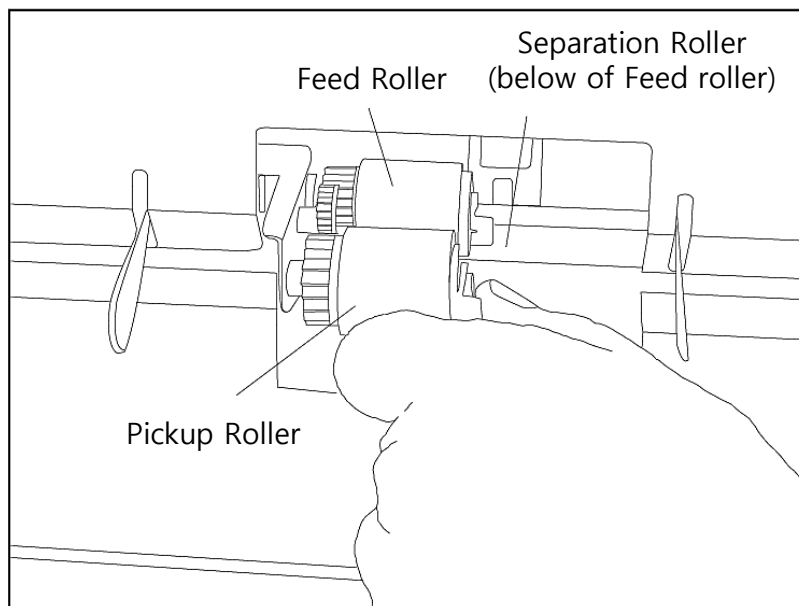

- ① Remove the Snap-Ring which is fixing the roller on the shaft.
- ② Remove the roller & clean by a soft clothing with alcohol.
- ③ After cleaning, put the roller back to the shaft & fix with Snap-Ring.

Cleaning

2 Fold Rollers

Since Pressure seal forms leave paper dust, ink and toner residues. It is very important to occasionally clean the surface of the each roller to maintain its best condition for better performance.



- ① Open the Safety Cover (Right) & pull out UCA.
- ② Clean each roller by a soft clothing with alcohol. Rotate the roller to clean all surface of roller.
- ③ Close the UCA & Safety Cover (Right).



Please do not use any other substance when cleaning the surface of the fold rollers as it may damage the rubber.

Memo

Memo

Memo

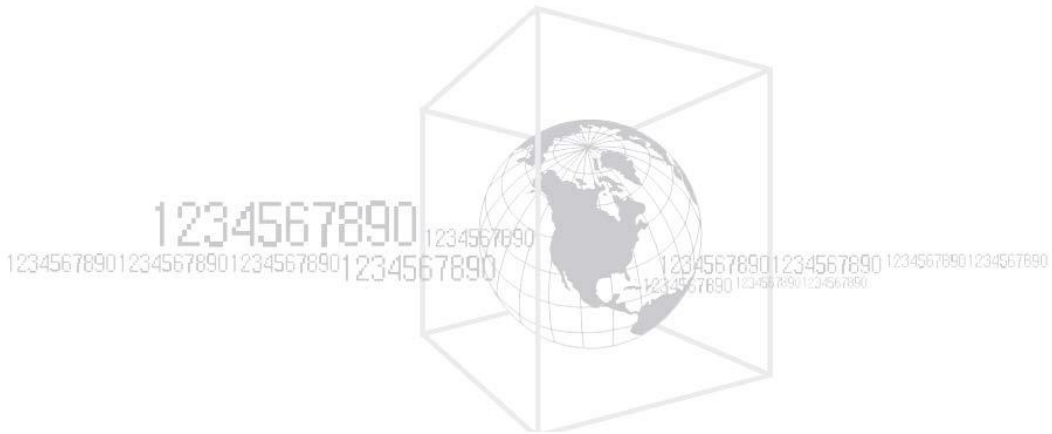

<http://www.paitec.com>