

## BANKNOTE COUNTER

User Manual

FEDPRO CR500

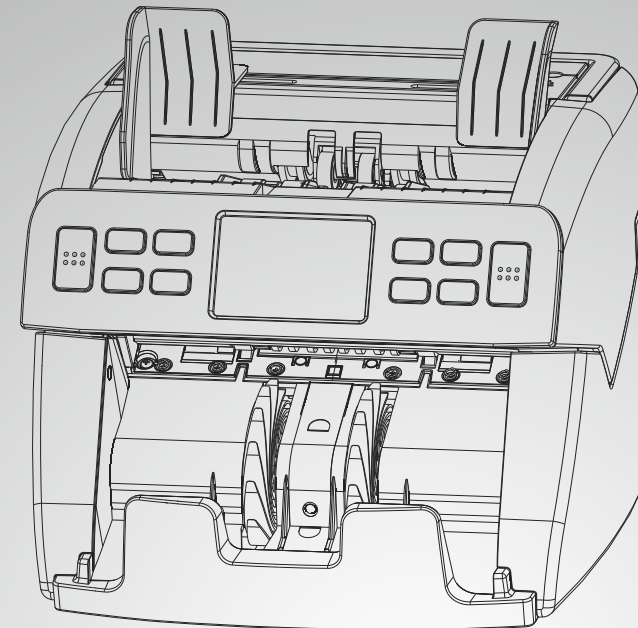

## Preface

---

Thank you for choosing the FedPro CR500 cash counter. This high-performance, intelligent, counterfeit cash counter uses industry leading digital processing technology and is suitable for counting/detecting the value of many currencies, including USD, EUR, ALL, etc. Our counter boasts durable hardware, improved performance, and enhanced counterfeit detection ability.

Prior to first use, please read this manual carefully to ensure you fully understand how to safely operate, and to avoid damaging the machine. Keep the manual in a safe place for future reference.

## Contents

---

1 Introduction .....	3
1.1 Important Notes and Safety Instructions .....	3
1.2 Unpacking .....	3
1.3 Figures Used .....	3
2 Model Overview .....	4
2.1 At a Glance .....	4
2.2 Control Panel Overview .....	4
2.3 Main Screen .....	6
2.4 Counting Result Screen .....	7
3 Operation .....	8
3.1 Currency Selection .....	9
3.2 Counting Modes .....	9
3.3 Batch Counting .....	10
3.4 ADD Function .....	10
3.5 Counterfeit Detection Function .....	10
3.6 Speed Setting .....	10
4 Maintenance .....	11
4.1 Note Path Access .....	11
4.2 How to Close Note Path .....	11
4.3 Clean the Device .....	11
4.4 Maintenance Settings .....	13
4.4.1 Setting External Display Type .....	13
4.4.2 Restore factory settings .....	14
4.4.3 Hardware Debugging .....	14
4.5 Change the Fuse .....	15
4.6 How to Adjust the Feeding Gap .....	15
4.7 Software Update .....	16

4.7.1 Via SD card.....	16
4.7.2 Via USB connection and Serial communication .....	16
5 Technical Specifications .....	19
Appendix Error Messages .....	20
Self-test Error Messages .....	20
Banknote Delivering Error Messages .....	20

## 1 Introduction

### 1.1 Important Notes and Safety Instructions

- The machine is exclusively for indoor use only. Do NOT use it outdoors.
- Maintenance must only be done by approved technicians. Do not attempt to disassemble the machine. If any problems occur, consult the troubleshooting guide. If the problem persists, please contact the authorized distributor for assistance.
- Do not expose the device to liquids, extreme humidity, or moisture. Avoid operating the device in environments with strong magnetic and electromagnetic fields (e.g. keep it away from magnets, other electrical appliances, etc.)
- Use the supplied power cord in a properly grounded outlet.

### 1.2 Unpacking

Check the machine for any damage from transit. Check that the machine is in good condition and that all the following accessories are available and undamaged:



CR500



User manual



Power cord



Cleaning brush



Fuse



USB cable (Optional)



SD card (Optional)



External display (Optional)

### 1.3 Figures Used

The figures in this manual are for illustrative purpose only and may differ from what is actually shown on the display.

## 2 Model Overview

### 2.1 At a Glance

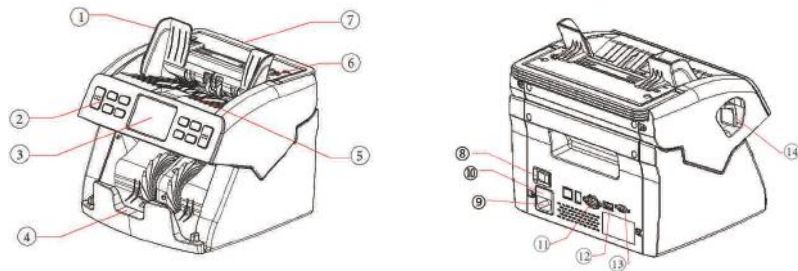

- |                                 |                                   |
|---------------------------------|-----------------------------------|
| 1) Hopper Guide                 | 8) Power Switch                   |
| 2) Control Panel                | 9) Power Socket                   |
| 3) LED Display                  | 10) Fuse Holder                   |
| 4) Banknote Stacker             | 11) DB9 Port for External Display |
| 5) Banknote Hopper              | 12) USB Port for Connection to PC |
| 6) Feeding Gap Adjustment Screw | 13) SD Card Slot                  |
| 7) Handle                       | 14) Note Path Access Door         |

### 2.2 Control Panel Overview

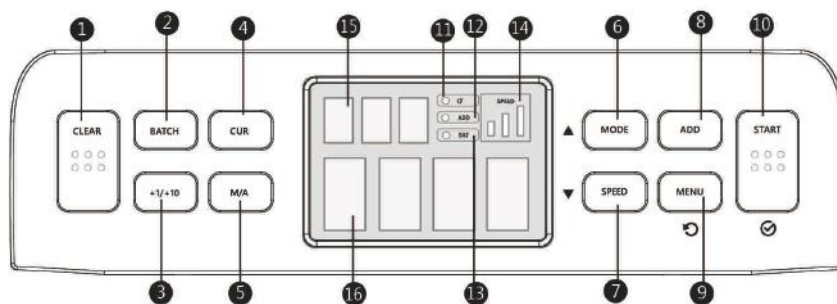

No.	Button	Description
1	<b>CLEAR</b>	Clear the number of the counted banknotes and batch function
2	<b>BAT</b>	Batch function on/off, and sets batch number.
3	<b>+1/+10</b>	Increases the batch number by either 1 (press to increase by 1) or 10 (press and hold).
4	<b>CUR</b>	Selection of desired currency.
5	<b>M/A</b>	Manual/automatic counting mode
6	<b>MODE</b>	Enable/disable counterfeit detection mode
7	<b>SPEED</b>	Set banknote counting speed
8	<b>ADD</b>	Enable/disable accumulation function
9	<b>MENU</b>	After the machine is powered on, press and hold <b>MENU</b> button to enter the maintenance menu
10	<b>START</b>	Continue counting

## 2.3 Main Screen

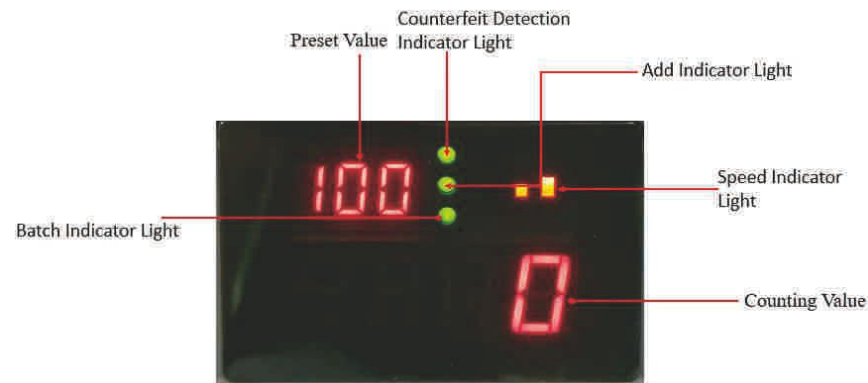
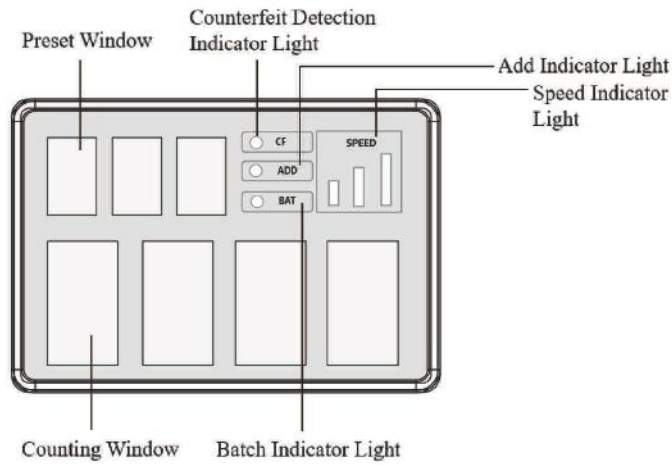

Name	Display Contents	Description
Counterfeit Detection Indicator Light(CF)	ON/OFF	Indicates the counterfeit detection function is ON/OFF
Add Indicator Light(ADD)	ON/OFF	Indicates the add function is ON/OFF
Batch Indicator Light(BAT)	ON/OFF	Indicate the batch function is ON/OFF
Speed Indicator Light(SPEED)	L/M/H	Indicates three speed level:low / middle / high
Preset Window	Currency code	Displays the current currency type
	Error message	Error code of delivering banknotes or error message of performing a self-test after powered on
	Batch Value	Set batch value
Counting Window	Counting value	The number of banknotes

## 2.4 Counting Result Screen



When all the banknotes in the hopper are counted, the LED will show the counting value of all the banknotes (as shown in the picture).

**Note:** The maximum number of notes counted is 9999. When the maximum value is exceeded, the count value is returned to zero.

### 3 Operation

Place the machine on a stable, flat surface away from strong electromagnetic fields and direct sunlight. To guarantee personal safety, only use grounded electric outlets. Plug the power cable into an electrical socket ensuring that all connections are secure. If you have purchased an external display, you may connect it to the DB9 port on the back of the machine.

Turn the power switch to the ON position. The machine will power up and will display the interface (as shown in Figure 1), the software version **C20** (as shown in Figure 2), and then perform a self-test. If the test is successful, the machine will enter its working status. If an error message appears on the LED display, please refer to the Error Messages section of the manual.

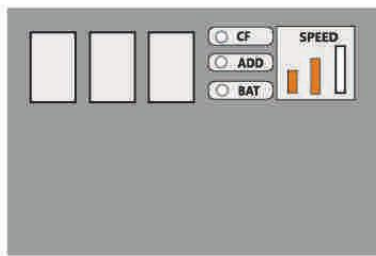

Figure 1

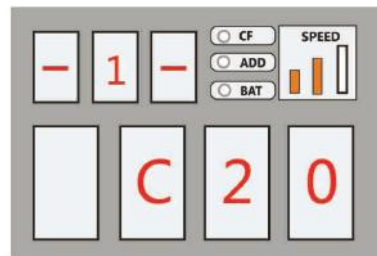

Figure 2

To avoid errors when counting banknotes:

1. Avoid counting wet, excessively dirty, or spoiled notes.
2. Always check for foreign objects which could jam the note path or even damage the sensors, e.g. paper clips, rubber bands, dust, etc.
3. Remove folds or curls from the notes before placing them in the hopper.
4. Align all the corners and edges of the notes as unevenness could cause errors.

Place the banknotes in order (as shown in Figure 3). Based on the size of the banknotes, adjust the left and right note guide to a suitable position. When ready, place the banknotes into the hopper (as shown in Figure 4). The machine will then start counting automatically.



Figure 3



Figure 4

When a counterfeit banknote is detected, the machine will stop immediately and the buzzer will sound. The top note in the stacker will either be counterfeit or a suspicious note which should be checked (as shown in Figure 5). Remove the counterfeit banknote and press the **START** button to continue counting.



Figure 5

When an error occurs or the machine automatically stops, please re-count the banknotes.

#### 3.1 Currency Selection

Press the **CUR** button to select your preferred currency. Continue pressing **CUR** to browse through the available currencies. The selected currency is shown on the top left of the display.

#### 3.2 Counting Modes

Press the **CUR** button to select your currency type. The **MODE** button enables you to switch on/off counterfeit detection function.

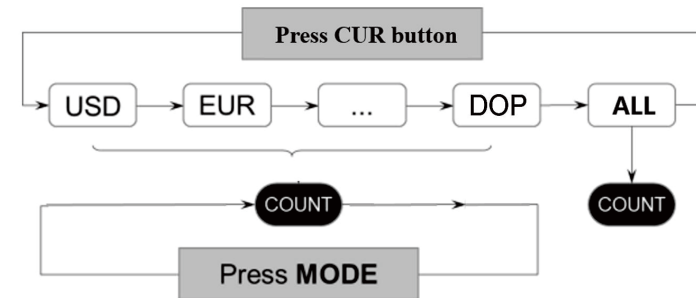

Figure 6

### 3.3 Batch Counting

A batch is where the machine is set to count a specific number of notes.

The default batch is 0 at start-up. When the machine is in a non-counting state, press the **BAT** button to turn the batch function on/off and set the batch value. When the batch function is set, the preset window displays the batch value. Pressing the **BAT** button several times switches the batch value continuously: 100 -> 50 -> 20 -> 10 -> 5 -> switches the batch function off -> 100 -> .....; pressing the **+1/+10** button switches the batch function on. Increases the batch number by either 1 (press to increase by 1) or 10 (press and hold). The maximum value of the batch value is 200. Beyond the maximum value, the value will not increase.

After setting the batch number, place a stack of banknotes on the hopper and the machine will start counting. When the specified number is reached, the machine will stop automatically. When the banknotes are removed from the stacker, the counter will begin counting the next batch.

### 3.4 ADD Function

Press the **ADD** button when the machine is in a non-counting state and the ADD indicator light will turn on. All banknote bundles will be counted together instead of restarting the counting with every new bundle.

### 3.5 Counterfeit Detection Function

The counterfeit detection is on by default when the machine is powered on. The machine has fluorescent, magnetic and infra-red detection functions. Press the **MODE** button to turn on or off the counterfeit detection method. The CF light is on when the counterfeit detection function is enabled. The CF light goes out when the counterfeit detection function is disabled in count-only mode.

### 3.6 Speed Setting

When the machine is in a non-counting state, press the **SPEED** button to set the speed level, in counterfeit detection mode, only two levels are available (speed level: low -> middle) while in counting mode, three levels are available (speed level: low -> middle -> high).

## 4 Maintenance

### 4.1 Note Path Access



Figure 7

### 4.2 How to Close Note Path



Figure 8

### 4.3 Clean the Device

You can prolong the lifespan of your device by keeping it clean.

**WARNING:** To avoid risk of electric shock, always disconnect the main power cable before cleaning the machine.

*How to clean the Note Path of machine:*

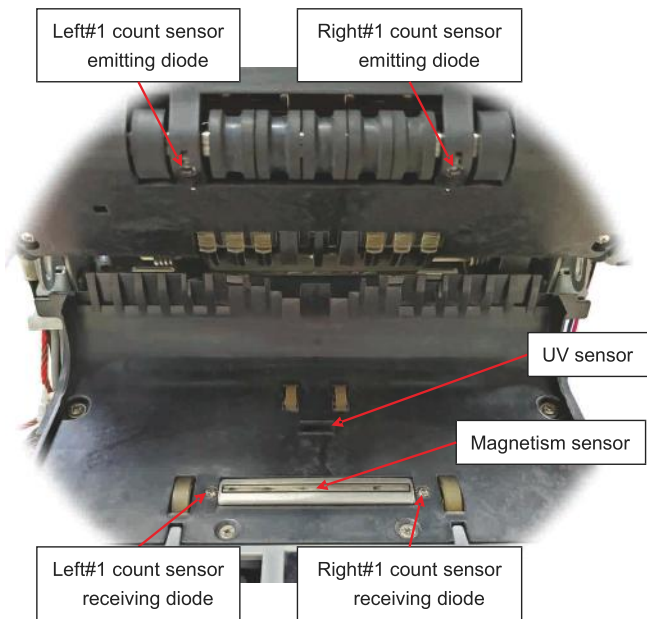

Figure 9

1. Open the note path door.
2. Gently wipe or dust the note path with a small, soft brush or a dry, soft, lint-free cloth.
3. If stains remain, moisten a soft, lint-free cloth with water or a 50/50 mixture of isopropyl alcohol and water that does not contain impurities.
4. Wring out excess liquid as much as you can.
5. Wipe the note path and the sensor surfaces again. Ensure no liquid gets inside the machine.

**Note:** Avoid spraying cleaner directly on the machine and be sure to dry the note path before closing it.

**How to Clean the Counter Case:**

When cleaning the machine, it's important that no liquid gets inside.

1. Prepare a 5:1 mixture of water to mild kitchen detergent (that's 5 parts water to 1-part detergent). The detergent must not contain abrasive powder or strong acid or alkaline chemicals.
2. Soak a sponge in the solution and then squeeze all excess liquid from the sponge.
3. Wipe the cover with the sponge, using a circular motion while taking care not to let any excess liquid drip inside the machine.
4. Wipe the surface to remove any excess detergent.
5. Rinse the sponge with clean, running water.
6. Wipe the cover with the clean sponge to remove any remaining detergent.
7. Wipe the surface again with a dry, soft, lint-free cloth.

8. Wait for the surface to dry completely and then remove any loose fibers.

**4.4 Maintenance Settings**

The device can use some built-in tools to assist in maintenance. The methods and operations for entering each mode are described below:

After power on, press and hold **MENU** button to enter the maintenance menu.

In maintenance Menu interface, the **CUR** and **M/A** buttons become the Up and Down navigation buttons.

**CUR:** Up

**M/A:** Down

Use the navigation buttons to select the desired setting.

Use the **START** button to confirm.

**NOTE:** The four modes of hardware debugging, UV resistance adjustment, production ageing and **DEBUG** require to switch off the power to exit these modes.

**4.4.1 Setting External Display Type**

**Step 1** Navigate to "2 LBd" in the maintenance menu and press **START** to confirm it. Or press and hold the **M/A** button, then switch on the machine and enter this settings mode.

**Step 2** Press **MODE** button (↑) and **SPEED** button (↓) to switch the external display type.



**Step 3** Press **START** button twice in a row to save the current selection. And exit this mode.

The following table shows the external display types:

External Display Types	External Display Definition
LED	LED
LCD	LCD
LEDD	R200GD
LEDH	HAILIANG
LED6	WX116
LED5	WX115

**Note:** only LED external display is available now, other external displays can be enabled if required.

#### 4.4.2 Restore factory settings

**Step1** Navigate to “3 dEF”, and press **START** to confirm. Or press and hold **CLEAR** button, then switch on the machine and enter this mode.

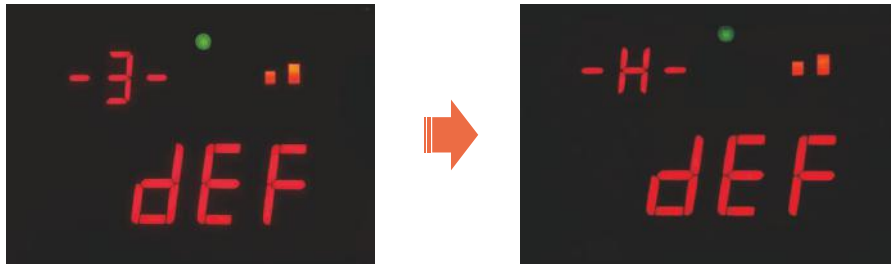

**Step2** Press **START** and the counting window will display "SUCC", and exit this mode.

(Then the machine will self-test and exit the mode.)



**Note:** When you have restored the factory settings, all parameters set by the user will be reset to the original factory setting.

#### 4.4.3 Hardware Debugging

**Step 1** Navigate to “7 HHH” in maintenance menu and press **START** to confirm it. Or press and hold **BAT** button, then switch on the machine and enter this mode.



**Step 2** Switch off the machine to exit the hardware debugging mode.

**Note:** The mode is available to maintenance personnel.

The button's detail is listed below:

Button	Function
START	Main motor ON/OFF
ADD	Stacker motor working/stop
BAT	LED light ON/OFF

#### 4.5 Change the Fuse

**WARNING:** To avoid risk of electric shock, always disconnect the main power cable before removing the fuse holder.



Figure 10

To change the fuse:

1. Disconnect the machine from the power.
2. Take the fuse holder out.
3. Replace the fuse.
4. Plug the fuse holder back in.

#### 4.6 How to Adjust the Feeding Gap

The feeding gap adjusting screw on the top cover is set by the factory. However, you may need to adjust the feeding gap as follows if the following problems occur during counting/sorting:

Frequent jams, or banknotes pass the feeder with difficulty – turn the adjusting screw anticlockwise to make the feeding gap wider.

Frequent “double notes” or “chained notes” error message – turn the adjusting screw clockwise to make the feeding gap narrower.

Note: The adjustment screw is very sensitive, please ensure that you only make minor adjustments.



Figure 11

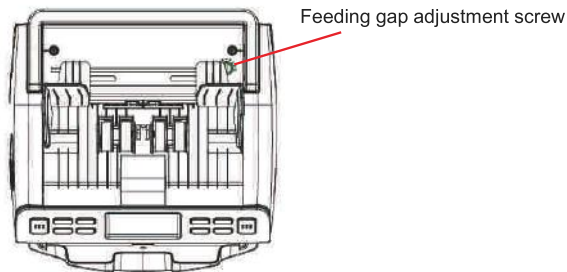

Figure 12

## 4.7 Software Update

The device can be updated via SD card, USB connection and Serial communication connection. The specific operation methods are as follows:

### 4.7.1 Via SD card

- Step1:** Copy the packaged CSB file to the "UPFILE" file on the SD card.
- Step2:** Insert the SD card into the proper interface at the backside of the machine.
- Step3:** At the beginning of the download, the counting window will display "- dn", and the preset window on the interface will run from 0 to 100.
- Step4:** After the update is finished, "SUCC" will be displayed on LED and the machine will automatically restart.
- Step5:** Remove the SD card from machine.

### 4.7.2 Via USB connection and Serial communication

The download procedure is as follows:

- Step1:** First connect the COM port on the PC with the banknote counter using a USB or serial cable connection;
- Step2:** Press "START" to power on the machine, the screen will display "-dn", while waiting for a response from the PC. USB communication and serial communication will be turned on at the same time, the system will download according to the selection of the upper computer.



- Step3:** Run the upgrade tool **Upgrade Tool v1.2** on PC. In the open window, click **Find Device** on the left side. If the connection is normal, the machine's information will be shown.



- Step4:** On the left side, click **Load File** and then select the ".CSB" file in the pop-up window.

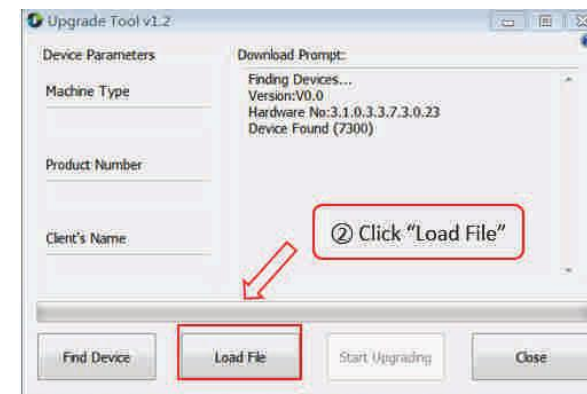

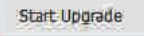
**Step5:** Click  button. If the connection is normal, the software will be automatically downloaded into machine. After receiving the upgrade file, the machine will start to upgrade automatically.

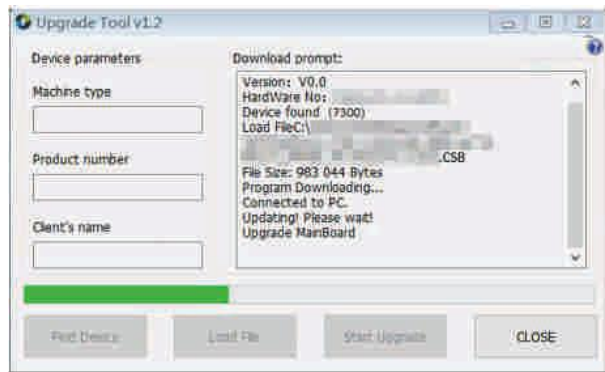

**Step6:** After the update is finished, the machine will automatically restart.



**Step7:** Click  button to close the upgrade tool.

Note: If the progress bar stops for a long time during the download process, please restart the download.

## 5 Technical Specifications

Counterfeit Detection:	MG, MT, UV, Thickness(detect double notes)
Counting Speed:	1,000/1,200/1,500 notes/min 1000/1200/notes/min: one currency with authentication 1500/notes/min: count only
Hopper Capacity:	300 notes
Stacker Capacity:	200 notes
Working temperature:	32°F ~ 104°F (0 ~ 40°C)
Humidity:	20~90%
Storage temperature:	-13°F ~ 140°F (-25 ~ 60°C)
Power supply:	AC100-240V, 50/60Hz
Power consumption:	<60W
Dimensions:	(L)10.35"x(W)10.55"x(H)10.04" ((L)263x(W)268x(H)255mm)
Weight:	13.23lb / 6.0kg
External interface:	RS232, USB, SD card

## Appendix Error Messages

### Self-test Error Messages

When the machine is switched on, there is a version number C20 showing up on the screen, after which the machine performs a self-test. If there is no error found during the self-test, the device enters the working state. If one error is found during the self-test, the error message will be displayed on the screen. If there are multiple errors, the next error is displayed after the current error is resolved. When all errors have been settled down, the device enters the working state.

Error message	Description	Solutions
E00	Fluorescence sensor error	If there are banknotes in the note path, exclude this banknote.
E10	Hopper banknote sensor error	Take out the banknotes from the banknote hopper.
E11	Stacker sensor error	Take out the banknotes from the Stacker.
E30	Left counting sensor error	If there are banknotes in the note path, exclude this banknote.
E31	Right counting sensor error	If there are banknotes in the note path, exclude this banknote.
E60	Main motor or rotate speed sensor error	

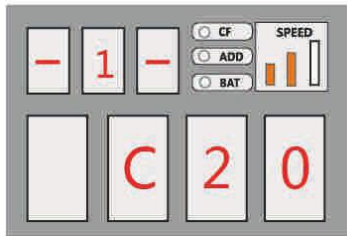

Figure 13 version number

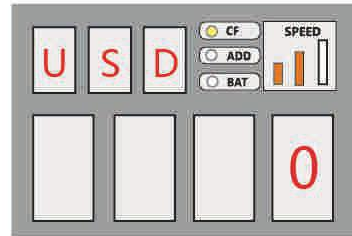

Figure 14 normal interface

### Banknote Delivering Error Messages

If an abnormality is detected during the counting process (e.g. counterfeit, mutilated or slanted banknotes, etc.), the machine will pause and display the detected error message in the preset window, which prompts the customer to deal with this error. When the user removes the banknotes from the stacker or presses the **START**

button to continue counting, the error message will disappear and the interface will go back to normal. The error codes and their descriptions are listed below:

Error message	Description	Solutions
F-F	Fluorescence error	<ol style="list-style-type: none"> <li>1. Counterfeit or suspicious banknote, remove it from the stacker and press <b>START</b> to continue the counting.</li> <li>2. Perform sensor calibration.</li> <li>3. If problem persists, replace UV sensor.</li> </ol>
F-C / F-1	Magnetic error	<ol style="list-style-type: none"> <li>1. Counterfeit or suspicious banknotes, remove it from the stacker and press <b>START</b> to continue the counting.</li> <li>2. Adjust the gap of the magnetic sensor and delivering wheel subassembly.</li> <li>3. If problem persists, replace magnetism board or magnetic sensor.</li> </ol>
Ed	Width error	<ol style="list-style-type: none"> <li>1. Remove the suspicious banknote and press <b>START</b> to continue counting.</li> </ol>
ES	Slant notes	<ol style="list-style-type: none"> <li>1. Tilted banknotes, ensure the banknotes are placed neatly and are centered on the hopper.</li> <li>2. Remove the slant note from the stacker and press <b>START</b> key to continue the counting.</li> <li>3. Use the hopper guides to center the banknote when counting a large stack of banknotes.</li> <li>4. If error is in high frequency, turn the adjusting screw anticlockwise to make the feeding gap bigger.</li> </ol>
EJ	Chained notes	<ol style="list-style-type: none"> <li>1. Some banknotes are attached to each other or overlapping, please re-count the banknotes.</li> </ol>
EC	Double notes	<ol style="list-style-type: none"> <li>2. If error is in high frequency, please turn the adjusting screw clockwise to make the feeding gap narrower.</li> </ol>
Eh	Incomplete notes	<ol style="list-style-type: none"> <li>1. Remove all notes from the stacker and pass them through the hopper again.</li> </ol>
FUL	The Stacker is full	<ol style="list-style-type: none"> <li>1. Remove all banknotes from the stacker.</li> </ol>