

**AMANO**

ELECTRONIC TIME RECORDER

**BX 6000** series

**OPERATION MANUAL**

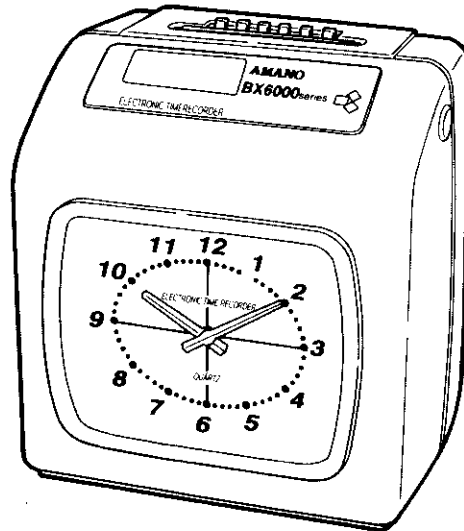

## ■ Important safety information

---

Precautions given in this manual are being categorized depending on the degree and content of hazardousness as follows. Do not fail to read these precautions carefully before starting use of this product.

 **Warning:** Warns possibilities of occurrences of fatal or serious physical injuries unless its content is duly observed.

 **Caution:** Cautions possibilities of occurrences of physical injuries or of material damages and losses unless its content is duly observed.

- Serious physical injuries includes losing the eyesight, suffering a physical injury, suffering a burn (high temperature or low temperature), receiving an electric shock, suffering a fracture and poisoning, which are to leave aftereffects or which require hospitalization or extensive attendance to the hospital to cure.
- Physical injuries include suffering a burn and receiving an electric shock although hospitalization or extensive attendance to the hospital may not be necessary to cure.
- Material damages and losses include damages and loses on houses, household belongings, livestock and pets.

### • Examples of illustrative indications



⊘ framing stands for a prohibition.

Specific content is being illustratively represented inside the circular frame.



The reversed circle framing stands for an indispensability.

Specific content is being illustratively represented inside the circular frame in reversed print.

# INTRODUCTION

Read this manual carefully for safe and proper use of the product. Also, after reading this manual, preserve it at a handy location for quick reference at needs.

- ◆BX6000 series time recorders will not operate normally unless installed in a proper environment. Do not install them outdoors or where they are exposed to rain.
- ◆The specifications, appearance, and descriptions are subject to change due to improvement.
- ◆This manual has been carefully prepared, but if you find any errors or any descriptions which you cannot understand clearly, contact the dealer from whom you have bought your time recorder.
- ◆Use or reproduction of this manual in part or in whole without the prior permission of AMANO Corporation is forbidden by law.

## List of Models

	BX6000	BX6200	BX6400
1-color printing	○		
2-color printing		○	○
Time signal		○	○
Melody		○	○
Automatic shift of print position			○
Printing during power failure	○	○	○
Initial print after time change	○	○	○
Counting the number of prints for attendance	○	○	○
Daylight savings time	○	○	○

# TABLE OF CONTENTS

<b>INTRODUCTION</b> .. 1	• Setting 2-Color Printing .. 32
<b>FOR THE OPERATIONAL SAFETY</b> .. 1	• Setting Time Signal .. 33
• After unpacking .. 3	• Setting Melody .. 34
• Components .. 3	• Setting Time Signal and Melody at the Same Time .. 35
<b>NAMES OF PARTS</b> .. 4	• Setting a Shift of Print Position .. 36
• Names of Exterior Parts .. 4	• Copying Set Items .. 38
• Programming Section .. 5	• Changing (Confirming) Set Items .. 39
<b>CAUTIONS WHEN INSTALLING</b> .. 8	• Canceling of Set Data .. 40
• Connecting the Battery Connector .. 8	• Additional Setting .. 40
• Installation .. 10	<b>Convenient function</b> .. 41
• Installation on a Wall .. 11	• When checking the total punches on the 1st "IN" button .. 41
• Connecting the Time Signal Wire .. 12	<b>TROUBLESHOOTING</b> .. 42
• Power Source .. 14	• Troubleshooting .. 42
<b>OPERATION</b> .. 15	• List of Error Codes .. 43
• Selecting the Print Column .. 15	<b>IF PRINTS BECOME DIM</b> .. 44
• Inserting Time Cards .. 16	<b>Maintenance</b> .. 45
<b>SETTING</b> .. 17	• Adjusting Melody Volume .. 45
• Removing the Upper Case .. 17	• Daily Maintenance .. 46
• Setting Imprint .. 18	<b>APPENDIX</b> .. 47
• Changing Pay Period Ending Date .. 21	• Specifications .. 47
• Setting the Clock .. 23	• Initial Values .. 48
• Day change time .. 26	• Weekly Program Setting Table .. 49
• Changing Time Signal Duration .. 27	
• Setting Daylight Savings Time .. 28	
• Before Setting Weekly Program .. 30	
• Setting Weekly Program .. 32	

# FOR THE OPERATIONAL SAFETY

Carefully read to fully appreciate the following warnings and cautions before starting use of the equipment.

## ⚠Warning



- Do not use with any power voltage other than that indicated on the product.

This could cause fire or electric shock.



- Do not overload power outlet.

This could cause fire or electric shock.



- Do not connect or disconnect power plug with wet hand.

This could cause electric shock.



- Do not damage or break power cord.

If a heavy object is put on it, or the cord is pulled or bent forcibly, the cord may be damaged and this could cause fire or electric shock.



- Do not remove any parts other than the upper case.

There is high voltage part inside, and touching it could cause an electric shock.



- Do not remodel the time recorder.

This may cause fire or electric shock.



- If any abnormality occurs such as smoke, smell or heat, disconnect the power plug from the power outlet and contact your dealer.

Continued use of the time recorder in the above cases could cause fire or electric shock.



- If foreign matter (metal piece, water or other liquid) get inside the time recorder, immediately disconnect the power plug from the power outlet and contact your dealer.

Continued use of the time recorder in this case cause fire or electric shock.



- Before connecting time signal line, disconnect power plug of time signal buzzer, etc. from power outlet.

If connected as is, it could cause fire or electric shock. (Only for models which can be connected to external time signal device)



- To avoid fire hazard, use only a fuse of the correct type, voltage rating, current rating as specified by the manufacturer:

Power source	Fuse
110-120V AC	250V,500mA
220-240V AC	250V,T500mA (Time Lag) with a low breaking capacity.

Use of any other materials for fuse will cause fire.

Make sure that the fuse has the proper specified capacity prior to use.



- When replacing the fuses, do not use fuses that exceed the specified capacity or use wire and silver paper.

Use of any other materials for fuse will cause fire.

Make sure that the fuse has the proper specified capacity prior to use.

### ⚠ Warning



- Do not pry open, disassemble or short the battery.

Abuse of the battery will cause fire or electric shock.



- In case of contact with the battery liquid, immediately flush affected area with plenty of water.

For eyes, flush with plenty of water and call a physician.

Failure to do so will cause blindness or serious burn.

### ⚠ Caution



- Replace the batteries by the same type of battery cell or equivalent as recommended by the manufacturer, using extreme care of their polarity.

Danger : Wrong batteries or wrong polarity may cause explosion.



- Do not install the time recorder in unstable or inclined place.

The time recorder could drop or fall, causing an injury.



- Do not put a water container or metal object on the time recorder.

If water or metal object gets inside the time recorder, it may cause fire or electric shock.



- Do not install this time recorder in any place where there is oily smoke or moisture near the cooking table or humidifier. Also do not install it in a dusty place.

Either of the above could cause fire or electric shock.



- The operator should be grounded first before starting maintenance and setting.

If maintenance and setting is started before he is properly grounded, the equipment may be damaged by static electricity.



- For mounting the time recorder on the wall, use a fixture suitable to wall material so that the weight of the unit can be securely held.

If not, the time recorder may fall, causing an injury.



- This equipment uses battery cells. Comply with your local regulations for disposal.

Illegal disposal will cause serious damage to people and environment.



- Be sure to hold the plug when the power plug is being disconnected from the power outlet.

If you pull the power cord, it may be damaged, causing fire or electric shock.









- Before replacing the ribbon cassette, remove the upper case and disconnect the power plug from the power outlet.

Replacing the ribbon cassette while the power plug is connected may cause injury or electric shock.

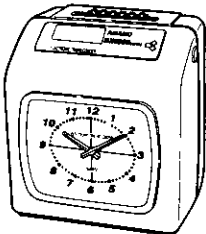
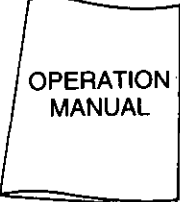
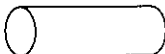
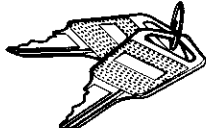
## After unpacking:

### Components

BX6000 series components are as follows. Be sure to check before operation that all components are supplied.

<input type="checkbox"/> BX6000 series time recorder 	<input type="checkbox"/> An operation manual (this manual) 	<input type="checkbox"/> Insulation tube CE marking spec. only (BX6200, 6400) 
<input type="checkbox"/> One pair of keys (two keys) 	<input type="checkbox"/> A spare fuse 110-120V AC...250V, 500mA 220-240V AC...250V, T500mA (Attached at the back of clock) 	<input type="checkbox"/> Seals for different languages 
<input type="checkbox"/> Wire holder A (BX6200, 6400) (two holders) 	<input type="checkbox"/> Wire holder B (BX6200, 6400) 	<input type="checkbox"/> Cross recessed head machine screw (set on the back plate) 

# NAMES OF PARTS

## Names of Exterior Parts

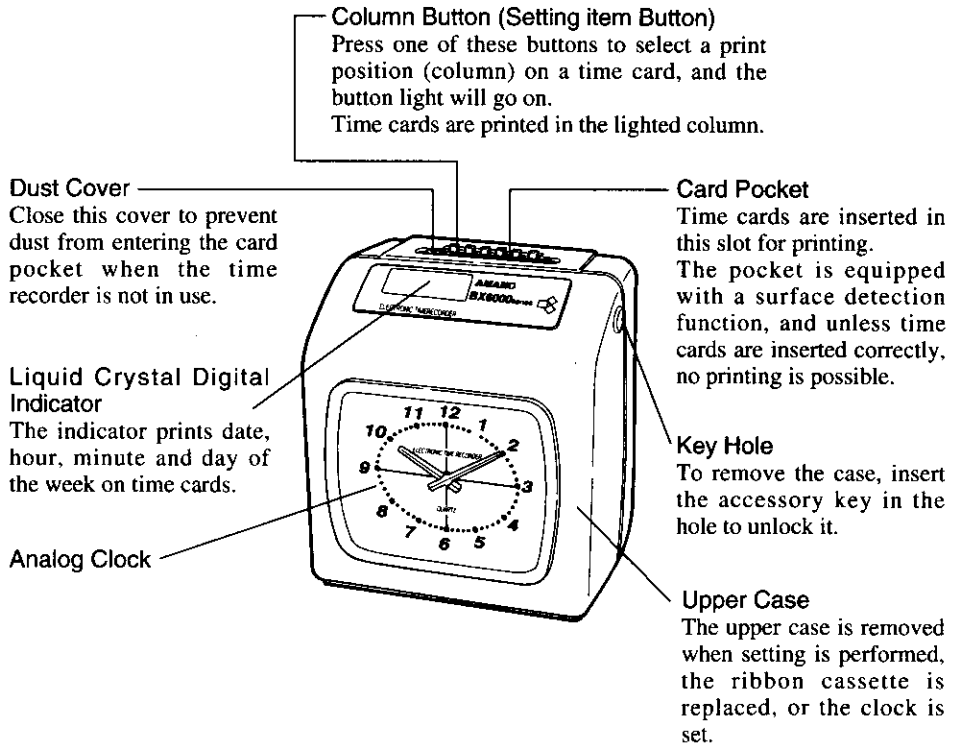

**Note:** Do not touch analog clock when the upper case is opened; The displayed time may drift.

## Programming Section

Remove the upper case to set each item. (See page 17.) Turn the dial at the left side to rotate the setting index. Setting index ①, setting index ② and setting index ③ can be selected.

Press the button at the front of the setting index to operate. For setting details see pages 18~ 40.

**Note :** The following explains the setting method according to the index of BX6200 index. The functions of BX6000 is different from those of BX6200, so parts of their indexes are blank.

### Setting Index ①

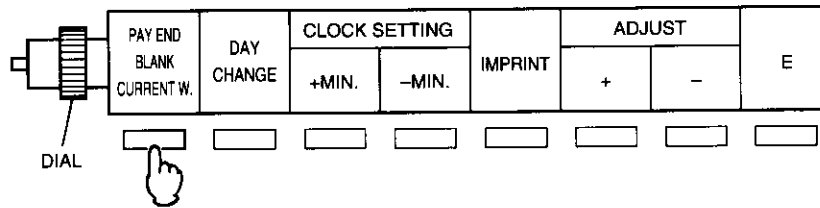

<b>PAY END BLANK CURRENT W.</b>	This button is used to select a pay period ending date or week, a blank row position on time card (monthly pay only) or a current week (in case of bi-weekly pay only). Press the "+" or "-" button to change the value.
<b>DAY CHANGE</b>	This button is used to change the time at which the date changes over. Press the "+" or "-" button to change the value.
<b>CLOCK SETTING + MIN.</b>	Each time this button is pressed, the clock advances one minute. Keep it pressed to advance the minute quickly. When this button is pressed, the clock will start running with the second set to "00" automatically.
<b>CLOCK SETTING - MIN.</b>	
<b>IMPRINT</b>	Use this button to change print formats such as card type. 24 hours/12 hours indication printing change, minute imprint, day of the week, etc.
<b>ADJUST +</b>	Press this button once to increase a set value by 1. Hold this button down to increase the set value quickly.
<b>ADJUST -</b>	
<b>E</b>	Press this button to register set values.

## Setting Index ②

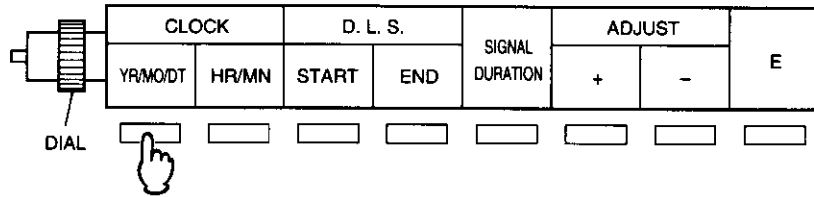

<b>CLOCK</b>	Use this button to change year, month, and day. To change these values, press the "+" or "-" button.
<b>YR/MO/DT</b>	
<b>CLOCK</b>	Use this button to change hour and minute. To change these values, press the "+" or "-" button.
<b>HR/MN</b>	
<b>D.L.S.</b>	Use this button to set the starting date of daylight savings time. The starting date can be set by designating a year, a month and date. The change-over time can be set at any time between one o'clock and nine o'clock in hour units. Change the value by pressing the "+" or "-" button.
<b>START</b>	
<b>D.L.S.</b>	Use this button to set the ending date of daylight savings time. If both the starting and the ending dates are set to the same date, the set daylight savings time is canceled. If only the starting date or the ending date is set, the daylight savings time function will not operate. Change the value by pressing the "+" or "-" button.
<b>END</b>	
<b>SIGNAL DURATION</b>	Use this button to change time signal duration. Change the value by pressing the "+" or "-" button. The initial value is 5 seconds.
<b>ADJUST</b>	Press this button once to increase a set value by 1. Hold this button down to increase a set value quickly.
<b>+</b>	
<b>ADJUST</b>	Press this button once to decrease a set value by 1. Hold this button down to decrease a set value quickly.
<b>-</b>	
<b>E</b>	Press this button to register set values.

Setting Index ③

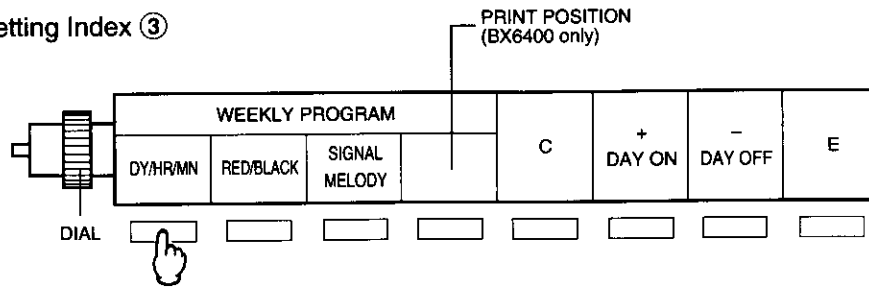

WEEKLY PROGRAM DY/HR/MN	Press this button to set day of the week, hour, and minute in a weekly program.
WEEKLY PROGRAM RED/BLACK	Press this button to set change-over of ribbon color for printing time cards in black or red in a weekly program.
WEEKLY PROGRAM SIGNAL MELODY	Press this button to set time signal and melody.
WEEKLY PROGRAM PRINT POSITION	Press this button to set shift of print column (BX6400).
C	Hold this button down for more than 2 seconds to cancel the content of the weekly program number displayed. (If this button is held down for less than 2 seconds, only the screen contents will be canceled, and the existing program contents will remain.)
+ DAY ON	When setting a weekly program, press this button to stop the day of the week from blinking and make it effective for the program. Hold this button down to advance any value quickly.
- DAY OFF	When setting a weekly program, press this button to extinguish the day of the week blinking and make it ineffective for the program. Hold this button down to decrease any value quickly.
E	Press this button to register set values.

## CAUTIONS WHEN INSTALLING

### Connecting the Battery Connector

#### ⚠ Warning



•Do not pry open, disassemble or short the battery. Abuse of the battery will cause fire or electric shock.



•In case of contact with the battery liquid, immediately flush affected area with plenty of water. For eyes, flush with plenty of water and call a physician. Failure to do so will cause blindness or serious burn.

#### ⚠ Caution



•Replace the batteries by the same type of battery cell or equivalent as recommended by the manufacturer, using extreme care of their polarity. Wrong batteries or wrong polarity may cause explosion.



•This equipment uses battery cells. Comply with your local regulations for disposal. Illegal disposal will cause serious damage to people and environment.

**1** Disconnect the power plug.

**2** Remove the upper case and back plate from the time recorder.

•Hold the back plate, pull the lower part toward you, and pull it down to remove it from the body.

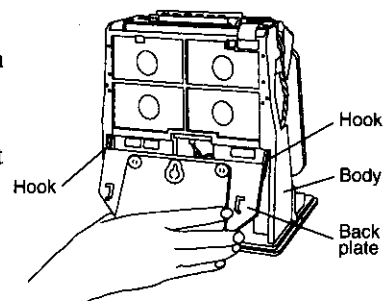
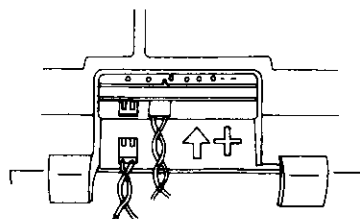

- 3** Connect the battery connector to the body. Insert both red cords in the arrow direction to the “+” side.

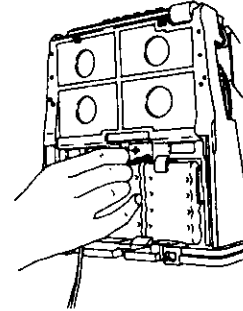

- 4** Set the back plate in the original place. Set the hooks on both sides of the back plate in the grooves on the body and push up to fasten them.

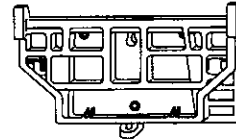

The time recorder has a built-in lithium battery as well, and the internal clock runs on the lithium battery.

Place the upper case on the time recorder, connect the power cord, and the clock indicates the present time.

## Installation

Proper installation and good power conditions will enable you to operate the time recorder for a long time.

### ⚠ Caution

- Do not install the time recorder in unstable or inclined place. The time recorder could drop or fall, causing an injury.
- Do not put a water container or metal object on the time recorder. If water or metal object gets inside the time recorder, it may cause fire or electric shock.
- Do not install this time recorder in any place where there is oily smoke or moisture near the cooking table or humidifier. Also do not install it in a dusty place. Either of the above could cause fire or electric shock.

### Installation location

- Prepare a stand about 75cm high.
- Install the time recorder horizontally.

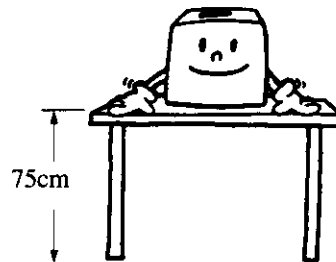

### Improper installation locations

- Places exposed to direct sunlight or close to heat sources

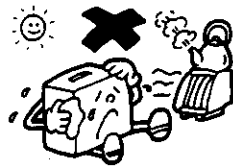

- Dusty or unstable places



- Places exposed to rain



- Places exposed to strong vibrations or shocks



## Installation on a Wall

### ⚠ Caution



- For mounting the time recorder on the wall, use a fixture suitable to wall material so that the weight of the unit can be securely held. If not, the time recorder may fall, causing an injury.

Do not insert power plug into power outlet until the time recorder has been mounted on the wall.

If there is no place to set the stand, mount the time recorder on the wall.

Prepare four 5mm wood screws.

- 1 Remove the upper case and the back plate from the time recorder.

- Hold the back plate, pull the lower part toward you, and pull it down to remove it from the body.
- Remove the screw from the back plate.

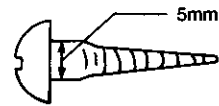

\*At this time, connect the battery to the body.  
(See Page 8.)

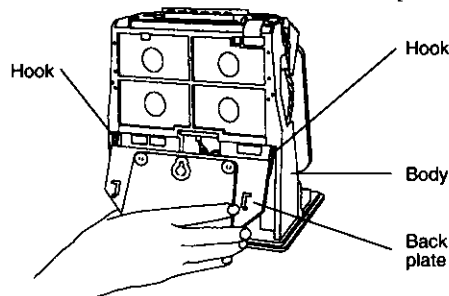

- 2 The tear drop hole and holes a, b, c on the removed back plate are half blanked. Push them completely through by using a screwdriver.

★ The size of holes a, b and c is 6.2mm across.

- 3 Attach the back plate at a proper height on a wall with a wood screw through the tear drop hole. Fix the back plate with wood screws through holes a, b and c.

- 4 Hang the body on the back plate. Set the hooks on both sides of the back plate in the grooves on the body and push up to fasten them.

- 5 Fix the screw which was set on the back plate, through d from below.

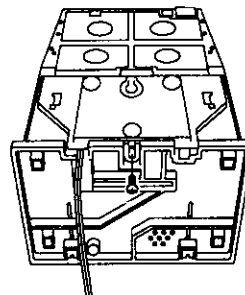
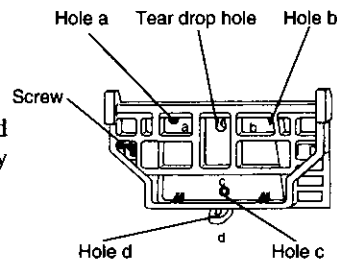

## Connecting the Time Signal Wire (BX6200, BX6400)

### ⚠ Warning

- Do not connect or disconnect power plug with wet hand. This could cause electric shock.
- Do not damage or break power cord. If a heavy object is put on it, or the cord is pulled or bent forcibly, the cord may be damaged and this could cause fire or electric shock.
- Before connecting time signal line, disconnect power plug of time signal buzzer, etc. from power outlet. If connected as is, it could cause fire or electric shock. (Only for models which can be connected to external time signal device)

### ⚠ Caution

- Be sure to hold the plug when the power plug is being disconnected from the power outlet. If you pull the power cord, it may be damaged, causing fire or electric shock.

Disconnect the power cord before connecting the time signal wire.

- 1 Remove the upper case and the back plate from the time recorder.
  - Hold the back plate, pull the lower part toward you, and pull it down to remove it from the body.

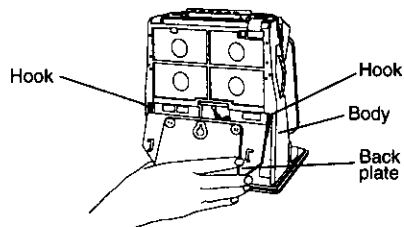

- 2 Pass the time signal wire through the hole on the bottom left side of the body.

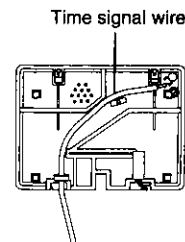

- 3** Press the protrusion of the time signal terminal and insert the time signal wire. Then secure time signal wire using wire holders A (two locations): One holder is to keep time signal wire from rising; the other is to keep the inserted time signal wire from coming off, by securing it at a position about 10 mm from the tip of the time signal wire. Cut the wire holder to proper length.

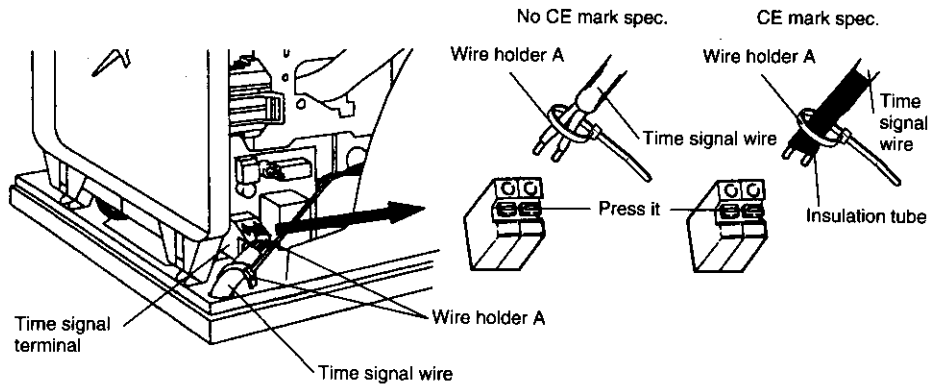

- 4** Secure the time signal wire on the bottom with wire holder B. Cut the cord holder to a proper length.

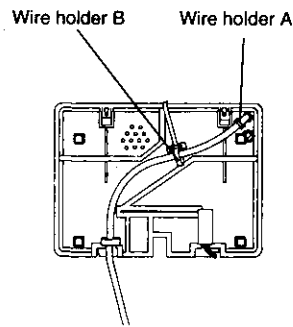

- Wiring Diagram of Time Signal Wire**  
To prevent malfunction due to noise, be sure to connect a noise absorbing capacitor on the time signal unit.

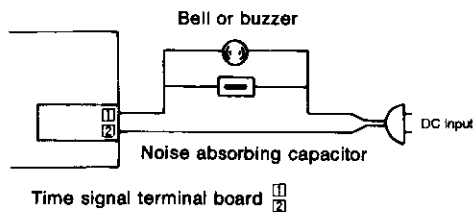

- Specifications for Connection**  
Time signal circuit : One circuit  
Contact capacity :  
•24V DC inductive load 0.5A max.  
•Contact output :  
No-voltage contact output

## Power Source

### ⚠ Warning

- ⊘ •Do not use with any power voltage other than that indicated on the product.  
This could cause fire or electric shock.
- ⊘ •Do not overload power outlet.  
This could cause fire or electric shock.
- ⊘ •Do not connect or disconnect power plug with wet hand.  
This could cause electric shock.
- ⊘ •Do not damage or break power cord.  
If a heavy object is put on it, or the cord is pulled or bent forcibly, the cord may be damaged and this could cause fire or electric shock.
- ⊘ •Do not remove any parts other than the upper case.  
There is high voltage part inside, and touching it could cause an electric shock.
- ⊘ •Do not remodel the time recorder.  
This may cause fire or electric shock.
- ⊘ •If any abnormality occurs such as smoke, smell or heat, disconnect the power plug from the power outlet and contact your dealer.  
Continued use of the time recorder in the above cases could cause fire or electric shock.
- ⊘ •If foreign matter (metal piece, water or other liquid) get inside the time recorder, immediately disconnect the power plug from the power outlet and contact your dealer.  
Continued use of the time recorder in this case cause fire or electric shock.

### ⚠ Caution

- ⊘ •Be sure to hold the plug when the power plug is being disconnected from the power outlet.  
If you pull the power cord, it may be damaged, causing fire or electric shock.

Insert the power plug into the power outlet.

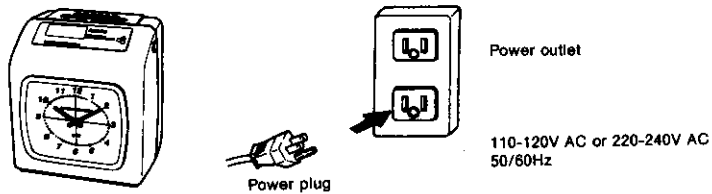

- Use a power source with a stable voltage.
- Use a power source that supplies continuous voltage and is independent of other equipment.
- The time recorder has a built-in lithium battery, on which the inner clock runs and which stores the programming data. (The battery is effective for three years of cumulative power failure hours.)

## OPERATION

### Selecting the Print Column

Press an appropriate IN or OUT button to select the print position for time cards.

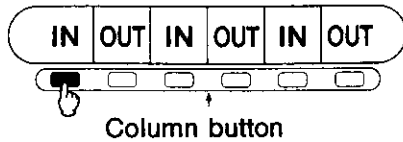

- ◆ Time cards are printed in the column where the column button light is on. To change the print position, press the button corresponding to the desired print position.

- ◆ **Print Position Shift (BX6400 only)**

The print position shifts automatically at the IN or OUT time set.

(Refer to "Setting a Shift of Print Position" for details.)

Even if Print Position Shift has been previously set, print position can be selected manually.

(Refer to "Setting Imprint" for details.)

## Inserting Time Cards



Insert a time card lightly in the card pocket.  
The card is automatically pulled in and printed.

### Surface Detection Function (see page 18.)

If a time card is inserted backwards by mistake, a long “beep” sound will occur, and the card will be rejected. (The surface detection function can be set only when the Monthly pay card is used.)

- ◆ Time cards are automatically pulled in. Do not push them in the card pocket by force, and do not try to pull them out during printing.
- ◆ If a time card is inserted upside down by mistake, it will be printed. Be careful to correctly insert time cards in the card pocket.
- ◆ Do not insert any objects other than time cards.

### Initial Print after Time Change

If the clock time has been adjusted to a time change of 5 minutes or more from the currently displayed time, the first printing after the change was made will print the “Hour” in small print. If the change in time is less than 5 minutes, the printing will remain as normal.

⌚ 8:20  
└ the “Hour” in small print

⌚ 8:28  
└ normal print

- The “Hour” is in small print for the first printing when the BX6000 series is first operated or after the time has been changed  $\pm 5$  minutes or more.
- If the parameters of daylight savings time is set on the day when the automatic time change is to take place, the first printing after the automatic time change will have the “Hour” in small print.
- If a time change of  $\pm 5$  minutes or more is made and the clock time is then switched back to within  $\pm 5$  minutes of the “actual time” (including the time that has elapsed), the printing will be normal.

**Note :** Since this is an easily recognized feature on time cards, it can also be used as a method of indicating any unauthorized time changes.

# SETTING

## Removing the Upper Case

### ⚠ Warning

- Do not remove any parts other than the upper case. There is high voltage part inside, and touching it could cause an electric shock.
- Do not remodel the time recorder. This may cause fire or electric shock.

### ⚠ Caution

- The operator should be grounded first before starting maintenance and setting. If maintenance and setting is started before he is properly grounded, the equipment may be damaged by static electricity.

Open the upper case when you adjust time, change pay period ending date, change year, month or day, replace ribbon cassette, etc. When upper case is removed, dot printer will move to a position where ribbon cassette can be replaced easily. Do not touch it.

**Note : Open/close the upper case with power turned on.**

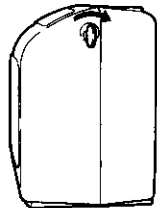

Insert the key into the keyhole and turn clockwise.

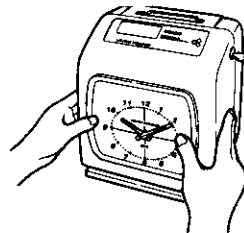

Remove the upper case.



Place the upper case on the time recorder, and the clock indicates the present time.

## Setting Imprint

Print formats are changed as follows :

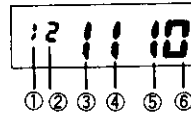

### ① Card Type

(with 6mm pitch)

Select from 1~8 the mode which applies to the card you use.

\*With 7mm pitch (special order), choose either "2" or "4".

1 : Monthly pay

2 : Upper step Weekly pay  
(Bottom space : 23mm)

3 : Upper step Weekly pay  
(Bottom space : 35mm)

4 : Lower step Weekly pay  
(Bottom space : 23mm)

5 : Lower step Weekly pay  
(Bottom space : 35mm)

6 : Bi-weekly pay  
(Bottom space : 23mm)

7 : Bi-weekly pay  
(Bottom space : 35mm)

8 : One-side monthly pay

} Upper step

} Lower step

} Bottom space

For BX6400, also available are :

0: Monthly pay surface detection not operational

1: Monthly pay surface detection operational

9: One-side monthly pay surface detection operational

### ② Surface Detection Function (BX6000/6200)

\* The surface detection function operates only when you use Amano time cards (monthly pay cards) or an equivalent with a surface detection cut-out.

When using a monthly pay time cards, select 1 or 2.

When using a weekly or bi-weekly pay time cards, 2 is automatically set.

1: "Surface detection function" operational

2: "Surface detection function" not operational

### Shifting Print position manually (BX6400)

1: "Shifting print position manually" operational

2: "Shifting print position manually" not operational

#### 1 : "Shifting print position manually" operational

Both automatic shifting of print column with weekly program and manual selection using column button can be used together.

When column button is pressed, the column position will be operational for 10 seconds. After printing is completed, or if no print is completed within 10 seconds after the column button is pressed, print position will return to the column which has been set by weekly program.

If no weekly program is set, column button will be operational continuously.

#### 2 : "Shifting print position manually" not operational

Print column shifts only by weekly program : Column position cannot be shifted manually.

If weekly program has not been set, note that printing cannot be done even if the card is inserted.

③ 24-hour/12-hour Indication Change-over  
 1 : 24-hour indication  
 2 : 12-hour indication

④ Hour Indication  
 1 : 24 hours (0~23 hours) (0 is not printed at the tens digit of hour. Example : 9:00)  
 2 : 12 hours (AM/PM hours) (Minute is underlined for PM. Example : 9:00)  
 3 : 24 hours (0~23 hours) (0 is printed at the tens digit of hour. Example : 09:00)

⑤ Minute Indication  
 1 : Minutes  
 2 : 1/100 hour A  
 3 : 1/100 hour B  
 4 : 1/10 hour

1/100 hour A, 1/100 hour B, and 1/10 hour:

Minute	0	1	2	3	4	5	6	7	8	9	~	29	30	31	32	33	34	35	~	54	55	56	57	58	59
1/100 hour A	00	02	03	05	07	08	10	12	13	15	~	48	50	52	53	55	57	58	~	90	92	93	95	97	98
1/100 hour B	00	00	00	05	05	05	10	10	10	15	~	45	50	50	50	55	55	55	~	90	90	90	95	95	95
1/10 hour	0	0	0	0	0	0	1	1	1	1	~	4	5	5	5	5	5	5	~	9	99	9	9	9	9

⑥ Day of The Week indication  
 0 : Date 1 : English 2 : Spanish 3 : French  
 4 : German 5 : Italian 6 : Japanese  
 7 : DAY No. (1~7) 8: No indication

Example : Set "Monthly pay" , "Shifting print position manually operational" "12-hour indication", "12-hour system printing", "1/100 hour B" and "Date printing".

- 1 Turn the dial of the setting index.

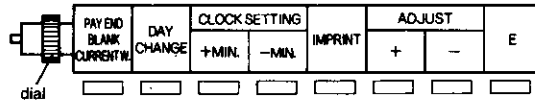

- 2 Press the IMPRINT button. The initial value will appear.



- 3 To change the card type, press the "+" or "-" button and set "1". Press the "E" button to register it.

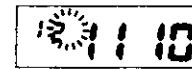

- 4 To change the shifting print position manually, press the "+" or "-" button and set "1". Press the "E" button to register it.



- 5 To change the 24-hour/12-hour indication, press the "+" or "-" button and set "2". Press the "E" button to register it.

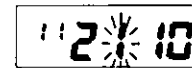

- 6 To change the hour indication, press the "+" or "-" button and set "2". Press the "E" button to register it.

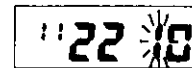

- 7 To change the minute indication, press the "+" or "-" button and set "3". Press the "E" button to register it.

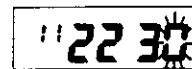

- 8 To change the day of the week indication, press the "+" or "-" button and set "0". Press the "E" button to register it.

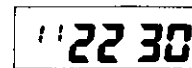

## Changing Pay Period Ending Date

Pay period ending date can be set three ways : weekly pay, bi-weekly pay and monthly pay. Select the desired one. Make the selection when setting imprint. (See pages 18).

### <Weekly pay>

Example : Set the pay period ending date to Monday.

- 1 Turn the dial of the setting index.

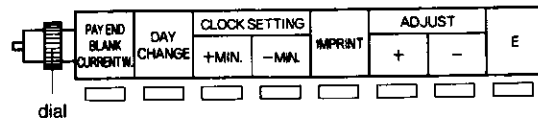

- 2 Press the PAY END button, and the initial value will appear. (The ▲ mark blinks at "FR".)



- 3 Press the "+" or "-" button and bring the ▲ mark to "MO". Press the "E" button, and the blinking ▲ mark stops blinking. The setting has been registered.

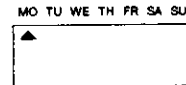

### <Bi-weekly pay>

Example : Set the pay period ending date to Sunday and the current week to the second week.

- 1 Turn the dial of the setting index.

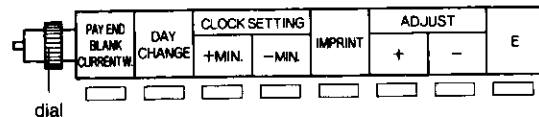

- 2 Press the PAY END button, and the initial value will appear. (The ▲ mark blinks at "FR", and the current week is the first week.)



- 3 Press the "+" or "-" button and bring the ▲ mark to "SU". Press the "E" button, and the blinking ▲ mark stops blinking. The setting has been registered.

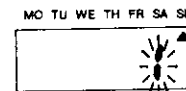

- 4 Press the "+" or "-" button to change the number to "2". Press the "E" button, and the blinking number stops blinking. The setting has been registered.



## <Monthly pay>

For the “Monthly Pay”, assign “pay period ending date” and “blank row”.

A blank row means a row is left blank out of the 32 rows on the front and back of a time card. The top row of the front is numbered 01 and the last row on the back is numbered 32. The desired row can be set by designating the number.

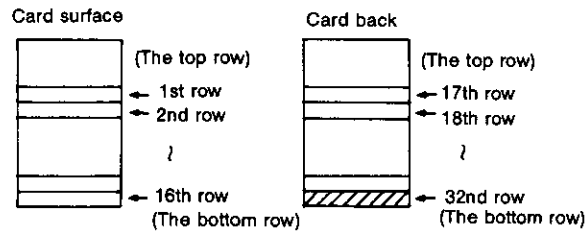

Example : Set the pay period ending date to the 25th and the blank row to the 17th.

- 1 Turn the dial of the setting index.

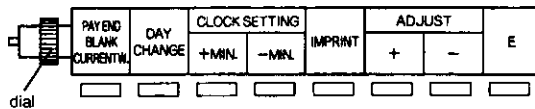

- 2 Press the “PAY END” button, and the initial value will appear. (The pay period ending date is the 31st, and the blank row is the 1st.)

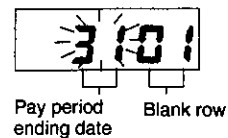

- 3 Press the “+” or “-” button to change the pay period ending date and set 25 in place of 31. Press the “E” button to register it.

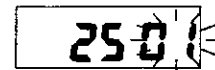

- 4 Press the “+” or “-” button to change the blank row and set 17 in place of 01. Press the “E” button to register it.

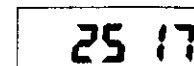

## Setting the Clock

There are two procedures : setting the minutes, and setting the date and hour.

Normally, clock is set by procedure shown in "Setting the clock".  
If date or time is wrong, correct the clock by procedure shown in "Setting the Date".

**Note :** When the clock is set right, the hands will move by themselves, so, never touch the hands.

### Setting Minutes

- 1 Turn the dial of the setting index.

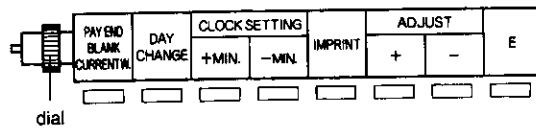

- 2 Correct the time by using the "+ MIN." and "- MIN." buttons.

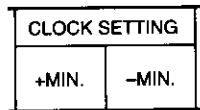

Each time this button is pressed, the clock advances one minute. Keep it pressed to advance the minute quickly. When this button is pressed, the clock will start running with the second set to "00" automatically.

Each time this button is pressed, the clock will decrement one minute. Keep it pressed to decrement the minute quickly. When this button is pressed, the clock will start running with the second set to "00" automatically.

**8:30**

When [+MIN.] or [-MIN.] button is pressed, the display will change to the clock.  
-If the clock is advanced or delayed only a few minutes, adjust the time by pressing [+MIN.] or [-MIN.] button.  
If the clock is advanced more than ten minutes, adjust the time by pressing [HR/MN] button described in Setting the Date.  
(See page25.)

## Setting the Date

Year, month, date, hour, and minute are set as follows.

Press the “+” or “-” button to change values. Be sure to press the “E” button before setting a new item or when registering values.

<Setting of Year, Month, and Date>

Example : Change December 18, 2000 to December 21, 2000.

- 1 Turn the dial of the setting index.

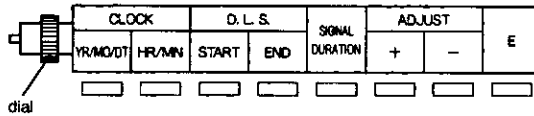

- 2 Press the “YR/MO/DT” button.

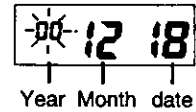

- 3 Press the “+” or “-” button to change the year and press the “E” button. If it is not necessary to change the year, press the “E” button.

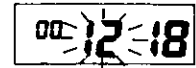

- 4 Press the “+” or “-” button to change the month and press the “E” button. If it is not necessary to change the month, press the “E” button.

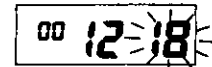

- 5 Press the “+” or “-” button to change the date. Press the “E” button to register the setting. If it is not necessary to change the date, press the “E” button.

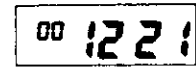

## <Setting of Hour and Minute>

Example : Change 18:00 to 8:30.

- 1 Turn the dial of the setting index.

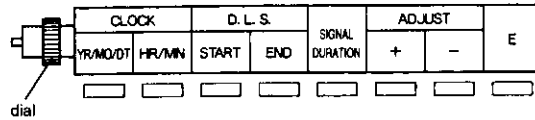

- 2 Press the "HR/MN" button.



- 3 Press the "+" or "-" button to change the hour. Press the "E" button to register the setting.

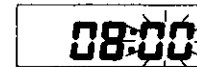

- 4 Press the "+" or "-" button to change the minute. When the "E" button is pressed, the clock hands will move to match the set time and the clock will start at 00 second.

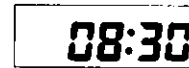

## Day change time (in case when one-day work finishes later than AM3:00)

This time recorder has been set so that row of the time card shifts at AM3:00. Printings from AM3:00 on current day to and AM2:59 the following day are printed on the same printing row.

Printing row shifts at AM3:00. If work of one day finishes later than AM3:00, IN time and OUT time will be printed in different rows.

DATE	MORNING		AFTERNOON		OVERTIME		HRS.
	IN	OUT	IN	OUT	IN	OUT	
1	6:22	25					
2			8	5:12			

If one day work normally exceeds AM3:00, alter the day change time to some other time (when no one is working).

Alter the day change time by hour units with the minutes place fixed to 00.

Example : Set the day time change at 6:00.

- 1 Turn the dial of the setting index.

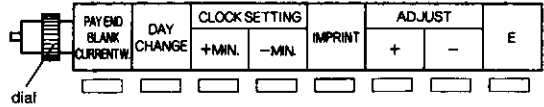

- 2 Press the "DAY CHANGE" button. The initial value will appear. (3:00)

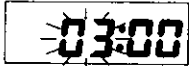

- 3 Press the "+" or "-" button, then set "06:00". Press the "E" button, and the blinking display will stop blinking. The setting has been registered.

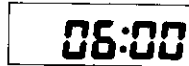

When the day change time is set to 6:00, time will be printed on the same row until 5:59 the following day.

DATE	MORNING		AFTERNOON		OVERTIME		HRS.
	IN	OUT	IN	OUT	IN	OUT	
1	6:22	25					
2			8	5:13			

## Changing Time Signal Duration

(BX6200,6400)

Time signal means that an external time signal device (bell, buzzer, etc.) sounds at the beginning/end of work time. Setting of time signal can be done using the weekly program. (See page 33.)

Example : Change the initial value to 10 seconds.

- 1 Turn the dial of the setting index.

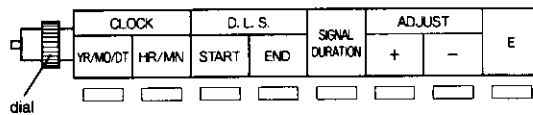

- 2 Press the SIGNAL DURATION button, and the initial value (5 seconds) will appear.

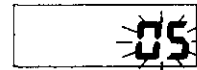

- 3 Press the "+" or "-" button to set the value at 10. Press the "E" button to register the setting.



Note: If duration is set to 00 second, the time signal will not sound even if the time signal has been set using weekly program.

## Setting Daylight Savings Time

Starting/ending dates and times of the daylight saving time are set as shown below.

- When the time reaches the registered starting time of the day beginning daylight saving time, the clock will advance 1 hour automatically.
- When the time reaches the registered ending time of the last day of daylight saving time, the clock will return 1 hour automatically.

### [Automatic updating the setting of daylight Saving Time]

For example, when starting date is set to April 2nd (Sunday) of 2000, and ending date is set to October 29th (Sunday) of 2000, the time recorder understands that the starting date is the 1st Sunday of April and ending date is the last Sunday of October. So, after the Daylight Saving Time period has ended, the setting of the Daylight Saving Time for following year will automatically be re-set as Starting date : April 1st (Sunday) of 2001, Ending date : October 28th (Sunday) of 2001. After setting the Daylight Saving Time once, it is not necessary to set again.

**Note :** This function works only when both the starting and ending dates of daylight savings time are set.

**Example :** Set the starting date and time to 5:00, April 2nd of 2000.

- 1 Turn the dial of the index.

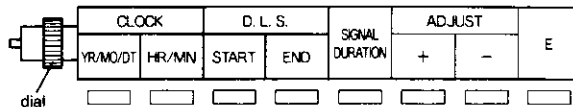

- 2 Press the "START" button.



- 3 When the "+" or "-" button is pressed, initial values of the starting year/month/date and this day of the week will be displayed.

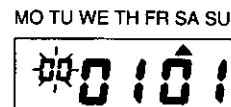

- 4 Press the “+” or “-” button to set the starting year.  
Press the “E” button to register the setting.

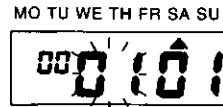

- 5 Press the “+” or “-” button to set the starting month.  
Press the “E” button to register the setting.



- 6 Press the “+” or “-” button to set the starting date.  
Press the “E” button to register the setting.

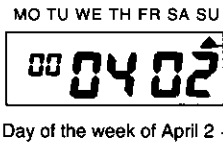

- 7 By pressing the “E” button again, starting time will be displayed.



- 8 Press the “+” or “-” button to set the starting time.  
Press the “E” button to register the setting.

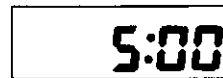

Note : Only Hour can be set for starting time.  
Minute will be fixed at 00.

- 9 Press the END button next to the START button.  
Setting of the ending year/month/date will start.  
Perform the setting of the ending date in the same way as setting of starting date.

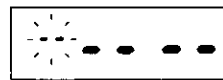

The setting of daylight saving time is completed.

- To confirm the setting contents  
After the setting has been completed, each time the START or END button is pressed, display will change between set date and time. The set value can be confirmed.
- To cancel the setting  
Set the starting and ending dates to the same date. The daylight saving time function will be invalidated.

## Before Setting Weekly Program

(BX6200, BX6400)

### Setting table preparation

Before setting a program, check the working conditions and prepare a setting table.  
Setting table is shown on page 49.

#### Example:

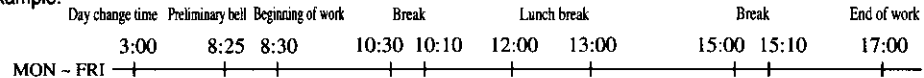

When working conditions are as shown above, enter the weekly program as follows:

#### ■ Weekly program

(In case of BX6400)

No.	HR MN	DAY							R/B	SIGNAL	MELODY	PRINTING POSITION
		MO	TU	WE	TH	FR	SA	SU				
1	3:00	▲	▲	▲	▲	▲	▲	▲			1234	①23456
2	8:25	▲	▲	▲	▲	▲					①234	123456
3	8:30	▲	▲	▲	▲	▲				○	1234	123456
4	8:31	▲	▲	▲	▲	▲			R		1234	123456
5	10:00	▲	▲	▲	▲	▲					12③4	123456
6	10:10	▲	▲	▲	▲	▲					123④	123456
7	12:00	▲	▲	▲	▲	▲				○	1234	123④56
8	13:00	▲	▲	▲	▲	▲				○	1234	123456
9	15:00	▲	▲	▲	▲	▲					12③4	123456
10	15:10	▲	▲	▲	▲	▲					123④	123456
11	17:00	▲	▲	▲	▲	▲			B	○	1234	123456

A maximum of 25 steps can be set for weekly program.

#### ◆ Melody is fixed by code shown below.

No.	Melody	Seconds
1	Greensleeves	32
2	Home on the Range	35
3	Westminster	15
4	Two Menuetto	10

◆ For 2-color printing, set to R: starting with red printing or B: starting with black printing.

◆ For shifting of printing column, set shifting columns (1-6).

## Setting Day of the Week and Time

In a weekly program, day of the week and time are set first, and other items such as 2-color printing, time signal, melody, and shift of print position are set later.

Example : Monday to Friday and 8:30

- 1 Turn the dial of the setting index. Then indicate the Program No.

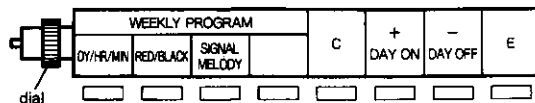

- 2 Press the DY/HR/MN button to begin setting.



- 3 Set day of the week.  
To set Monday to Friday, press the +/DAY ON button.  
To set Saturday and Sunday, press the -/DAY OFF button. Then, press the "E" button to register the setting.



- 4 Set Hour.  
Press the +/DAY ON button or -/DAY OFF button to set the hour. Press the "E" button to register the setting.

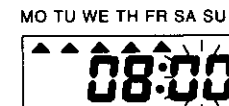

- 5 Set Minute.  
Press the +/DAY ON button or -/DAY OFF button to set the minute. Press the "E" button to register the setting.



- 6 Other items can be set.  
If incorrect setting is made, return to the display in step "5" and press DY/HR/MN button to perform setting again. Or press "C" button for two seconds until beep sound is heard and repeat from step "2".



Refer to page 32 and following pages for operation procedures from here.  
More than 1 item can be set, and their order does not matter.

## Setting Weekly Program

### Setting 2-Color Printing (BX6200, BX6400)

It is possible to change printing color to distinguish between regular work hours, starting late, and leaving early. Set the desired day of the week first, then set 2-color printing.

Example : Set printing in red at 8:31, and Monday to Friday.

- 1 Turn the dial of the setting index.

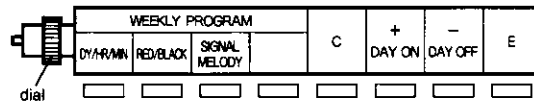

P-01

- 2 Set day of the week and time.  
\* Refer to "Setting day of the Week and Time" (Page 31).

MO TU WE TH FR SA SU  
^ ^ ^ ^ ^ ^ ^ ^  
08:31

- 3 Press the RED/BLACK button.

MO TU WE TH FR SA SU  
^ ^ ^ ^ ^ ^ ^ ^  
R- 08:31

- 4 Select the color.  
R : Start of red printing.  
B : Start of black printing.  
No indication : No 2-color printing is made.  
Press the +/DAY ON button or the -/DAY OFF button to select the color.

MO TU WE TH FR SA SU  
^ ^ ^ ^ ^ ^ ^ ^  
R- 08:31

- 5 Press the "E" button.  
To set other weekly programs, proceed to other items after pressing the "E" button.

MO TU WE TH FR SA SU  
^ ^ ^ ^ ^ ^ ^ ^  
R- 08:31

- 6 Press the "E" button again.  
When the next program number appears, the registration is completed.

P-02

- 7 Set Program No. 2.  
MO~FR, 17:00 and B: Black print are set to P-02.  
Note: If R and B are set at the same time, R print will have priority.

MO TU WE TH FR SA SU  
^ ^ ^ ^ ^ ^ ^ ^  
B- 17:00

## Setting Time Signal (BX6200, BX6400)

It is possible to sound external time signals to signal starts and ends of breaks and working hours. Set the desired day of the week first, and then set signal time.

Example : Set a time signal sound at 8:30, Monday to Friday.

- 1 Turn the dial of the setting index.

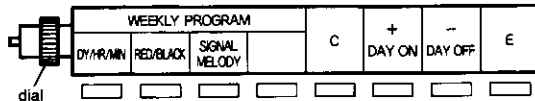

- 2 Setting day of the week and time.  
\* Refer to "Setting day of the Week and Time" (Page 31).



- 3 Press the SIGNAL/MELODY button..



- 4 Select whether the time signal is sounded or not.  
When  is indicated, the time signal sounds.  
When no mark is shown, the time signal does not sound.  
Select any of the above by using the +/DAY ON button or the -/DAY OFF button.



- 5 Press the "E" button.  
When time signal is set, "♪" blinks. For setting melody, refer to page 34.



- 6 Release the setting of melody.  
Setting of melody is released by pressing "E" button.  
To set other weekly programs, proceed to other items after pressing the "E" button.



- 7 Press the "E" button again.  
When the next program number appears, the registration is completed.

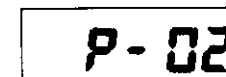

## Setting Melody (BX6200, BX6400)

It is possible to play melodies to signal starts and ends of breaks and working hours. Set the desired day of the week, and then set a signal time.

Example : Set "Westminster" to play at 8:30 Monday to Friday.

- 1 Turn the dial of setting index.

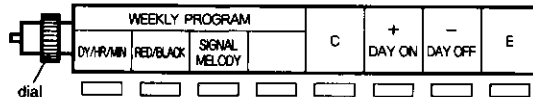

- 2 Setting day of the week and time.  
\* Refer to "Setting day of the Week and Time" (Page 31).



- 3 Press the SIGNAL/MELODY button.  
When ☑ is indicated, the time signal sounds.  
When no mark is shown, the time signal does not sound.  
If time signal is also to be set, refer to page 35.



- 4 Press the button once again.



- 5 Select a melody.  
No indication :  
No melody is played.  
1 : Greensleeves  
2 : Home on the Range  
3 : Westminster  
4 : Two Menuetto  
Press the +/DAY ON button or the -/DAY OFF button to select a melody.



- 6 Press the "E" button.  
To set other weekly programs, proceed to other items after pressing the "E" button.



- 7 Press the "E" button again.  
When the next program number appears, the registration is completed.

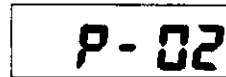

Note: If different melodies are set at the same time, melody with higher program No. has priority. Melody with lower program No. will not sound.

## Setting Time Signal and Melody at the Same Time (BX6200, BX6400)

It is possible to sound external time signals and play melodies to signal starts and ends of breaks and working hours. Set the desired day of the week first, and then set signal time.

Example : Set a time signal sound and "Home on the Range" to play at 8 : 30, Monday to Friday.

- 1 Turn the dial of the setting index.

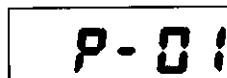
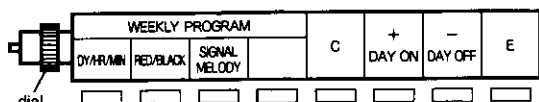

- 2 Setting day of the week and time.  
\* Refer to "Setting day of the Week and Time" (Page 31).



- 3 Press the SIGNAL/MELODY button.  
When is indicated, the time signal sounds.



- 4 Press the "E" button.  
When time signal is set, blinks.



- 5 Select a melody.  
No indication :  
No melody is played.  
1 : Greensleeves  
2 : Home on the Range  
3 : Westminster  
4 : Two Menuetto  
Press the +/DAY ON button or the -/DAY OFF button to select a melody.



- 6 Press the "E" button.  
To set other weekly programs, proceed to other items after pressing the "E" button.



- 7 Press the "E" button again.  
When the next program number appears, the registration is completed.

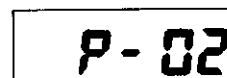

## Setting a Shift of Print Position (BX6400)

Print columns automatically shift from 1st column to 6th column at the designated time. Print columns can be set to "IN" for reporting time range, "OUT" for quitting time range.

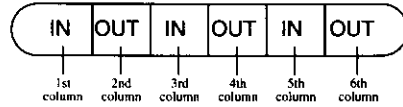

Example : The print column moves to the 1st column at 3:00 and the 4th column at 12: 00 Monday to Friday.

- 1 Turn the setting index.

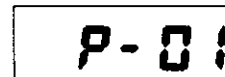
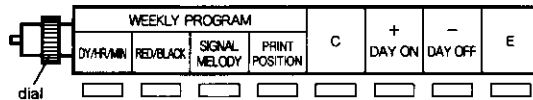

- 2 Setting day of the week and time.  
\* Refer to "Setting day of the Week and Time" (Page 31).



- 3 Press the PRINT POSITION button.



- 4 Select a print column.  
Press the +/DAY ON button or the -/DAY OFF button to select a print column position.

1~6: Print column shifts to 1~6.  
No indication: Print column does not shift.



- 5 Press the "E" button.  
To set other weekly programs, proceed to other items after pressing the "E" button.



- 6** Press the "E" button again.  
When the next program number appears, the registration is completed.



- 7** Set Program No. 2.  
MO~FR, 12:00, 4 (shifted to 4th column) are set in P-02.



**Note:** If different columns are set at the same time, column with higher program No. has priority. Column with lower program No. does not shift.

## Copying Set Items (BX6200,BX6400)

Set items (day of the week, time) can be copied in the next program. Setting time can be reduced by changing the copied data. When time and day of the week have already been set, hold the "E" button down for more than two seconds copy them. When the next program has been set, they are copied in the next program in which no data has been set.

Example : Set "Greensleeves" to play at 9 : 00 Monday to Friday and also "Westminster" to play at 12 : 00 by using the copying function.

- 1** Set a weekly program in which the Greensleeves is played at 9 : 00.



- 2** Hold the "E" button down for two seconds, and an empty program number will be indicated.



- 3** Release the "E" button, and the day of the week and time will be copied.



- 4** Press the +/DAY ON or the -/DAY OFF button to change to the desired time.



- 5** Set the melody, and press the "E" button.  
(Page 34)



- 6** Press the "E" button again.  
When the next program number appears, the registration is completed.

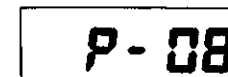

## Changing (Confirming) Set Items (BX6200,BX6400)

A weekly program is changed (confirmed) as follows :

Example: In Program No. 5, melody of "Greensleeves" sounds at 9:00, Monday to Friday, is to be changed to "Westminster".

- 1** Press the +/DAY ON or -/DAY OFF button to indicate the number of the program to be changed (confirmed).

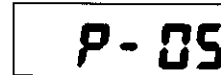

- 2** Press the "E" button, and the contents of the program to be changed (confirmed) will be displayed.



- 3** Press the button of the item to be changed. To set melody, press SIGNAL/MELODY button twice.

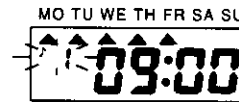

- 4** Change the setting and press the "E" button. Press the +/DAY ON button or the -/DAY OFF button to change the contents to the desired ones.



No indication :  
No melody is played.  
1 : Greensleeves  
2 : Home on the Range  
3 : Westminster  
4 : Two Menuetto

- 5** Press the "E" button again. When the next program number appears, the registration is completed.

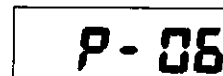

### Canceling of Set Data (BX6200,BX6400)

Weekly programs can be canceled as follows : the contents of a program to be canceled are confirmed before cancellation, but they can be canceled while their numbers are displayed.

Example : Cancel the set data of Program No. 5.

- 1 Press the +/DAY ON or -/DAY OFF button to select Program No. 5.



- 2 Press the "E" button, and the contents of the program to be canceled are displayed.



- 3 Hold the "C" button down for two seconds. When you hear a long "beep" sound, the cancellation is completed.

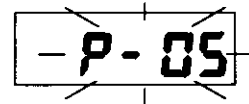

Time display becomes --:--.

Pressing C button again returns display to Program No.

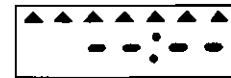

### Additional Setting (BX6200,BX6400)

Weekly programs can be added as follows :

Example : Add set data to an empty program (Program No. 5).

- 1 Display a program number on the display and hold the "E" button down for two seconds, and an empty program number will appear. (The next program in which no data has been set.)



- 2 Set data to be added.



## Convenient function

### When checking the total punches on the 1st "IN" button :

You can check the total punches on the 1st "IN" button made during a day.  
(This is useful for reserving box lunches, checking missing printing, etc.)

One day

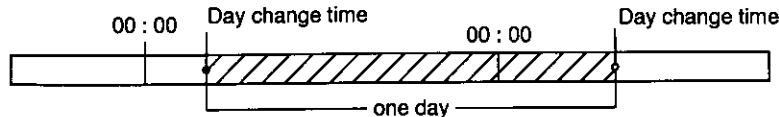

Day change time has been set to AM3:00.

#### ●To display count:

At time display screen, press 5th and 6th column buttons simultaneously, and the total number of punches on the 1st "IN" will be displayed.

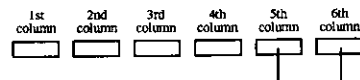

Number of punches on the 1st "IN"

All column button lamps go off and the number of punches on the 1st "IN" will be displayed.

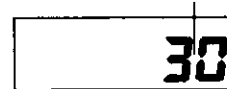

A maximum of 4 digits number (up to 9999 punches) can be displayed for count number. After releasing 5th and 6th column buttons, count will be displayed for 2 seconds, after which screen will return to time display.

#### ●To clear the total number of punches in the middle of a work day:

At time display screen, press 1st and 6th column buttons simultaneously for 2 seconds or more.

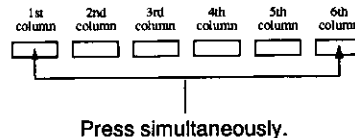

Number of punches on the 1st "IN" until current time

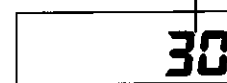

Press button for 2 seconds or more.



Beep sound will be heard and the number of punches on the 1st "IN" will be cleared.

Display changes to 0.

\* If buttons are released within 2 seconds, screen returns to time display and the number of punches will not be cleared.

◆After one day has elapsed (passing the day change time), the punches on the 1st "IN" button will be automatically cleared to 0.

# TROUBLESHOOTING

## Troubleshooting

### ⚠ Warning



- Do not connect or disconnect power plug with wet hand. This could cause electric shock.
- Do not damage or break power cord. If a heavy object is put on it, or the cord is pulled or bent forcibly, the cord may be damaged and this could cause fire or electric shock.

### ⚠ Caution



- Be sure to hold the plug when the power plug is being disconnected from the power outlet. If you pull the power cord, it may be damaged, causing fire or electric shock.

Trouble	Causes and Corrective Measures	
The time recorder does not accept time card.	Power failure	⇒ Wait until power supply is restored.
	The power cord is disconnected.	⇒ Insert the power plug firmly into the power outlet.
	Cards were inserted or pulled out by force.	⇒ Pull the power plug out of the power outlet, then insert it again.
Electronic sound is heard with no printing.	The card was inserted in the card pocket backwards.	⇒ Insert it in the pocket the other way round.
A long "beep" sound is heard without printing.	The card was not correctly inserted in the card pocket.	⇒ Insert it in the pocket with slight pressure.
The clock does not run.	Power failure	⇒ Wait until the power supply is recovered.
	The power cord is disconnected.	⇒ Insert the power plug firmly in the power outlet.
	The movement malfunctions.	⇒ Pull the power plug out of the power outlet, then insert it again.
The clock is slow. (or fast)	Mistakes in setting the clock.	⇒ Set it correctly referring to "Setting Minutes" (Page 23).
	Power failure.	⇒ Reset it referring to "Setting the Date" (Page 24).
	The movement malfunctions.	⇒ Pull the power plug out of the power outlet, then insert it again.
The date is set incorrectly.	Mistake in setting date.	⇒ Reset the date referring to "Setting the Date" (Page 24).
Light printing (Imperfect printing).	The ribbon is worn out.	⇒ Replace the ribbon cassette.
	The ribbon cassette is not set correctly.	⇒ Set it correctly.
The print position is wrong.	Incorrect setting of pay period ending date, etc.	⇒ Set them correctly referring to "Changing Pay Period Ending Date" (Page 21) for an example.
	Improper use of the time recorder.	⇒ Explain how to insert cards in the card pocket and how to remove them.
Unclear printing	Improper use of the time recorder.	⇒ Explain how to remove a card from the card pocket.

After all the above items have been checked, if the time recorder does not operate correctly, contact your dealer. Do not disassemble or lubricate, etc.

## List of Error Codes

When the IN/OUT button lamp has gone out with an error signal, a problem may have occurred inside the time recorder. Disconnect the power cord, and after a while connect it to the power outlet. If the time recorder does not return to normal, check the error indication and contact the dealer from whom you bought the time recorder.

Error No.	Meaning of Error	Measures
Err 1	Error of clock home position sensor	Contact the dealer from whom you bought the time recorder.
Err 2	Error of column home position sensor	
Err 3	Error of printing timing pulse sensor	
Err 4	Shading sensor error	Insert the card again.

\* In case of Err 1 time cards can still be printed on.

With Err 2 or Err 3, printing is impossible; printing is also impossible when Err 4 continuously occurs.

Message	Causes and Corrective Measure
	<p>During a power failure the built-in Ni-cd battery became weak.            ⇒ Change the battery after the power supply has been restored.</p>

## IF PRINTS BECOME DIM (replacing the Ribbon Cassette)

### ⚠ Warning



• Do not connect or disconnect power plug with wet hand. This could cause electric shock.



• Do not damage or break power cord. If a heavy object is put on it, or the cord is pulled or bent forcibly, the cord may be damaged and this could cause fire or electric shock.



• Do not remove any parts other than parts the removal procedure of which are described in this item. There is high voltage part inside, and touching it could cause an electric shock.

### ⚠ Caution



• Before replacing the ribbon cassette, remove the upper case and disconnect the power plug from the power outlet. Replacing the ribbon cassette while the power plug is connected may cause injury or electric shock.



• Be sure to hold the plug when the power plug is being disconnected from the power outlet. If you pull the power cord, it may be damaged, causing fire or electric shock.

When upper case is removed, dot printer will move to a position where ribbon cassette can be replaced easily. Do not touch it.

**1** Remove the upper case.

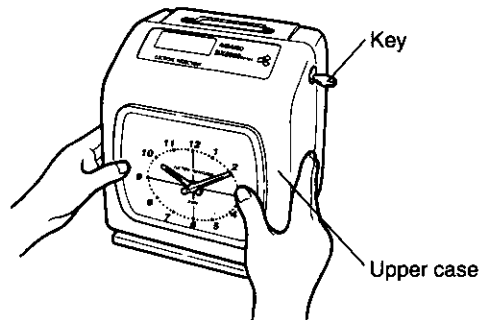

**2** With the dot printer moved to the center, disconnect the power plug from the power outlet. Grasp the handle of the liquid crystal digital indicator and lift it.

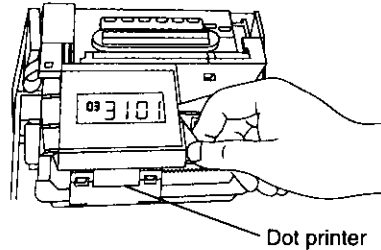

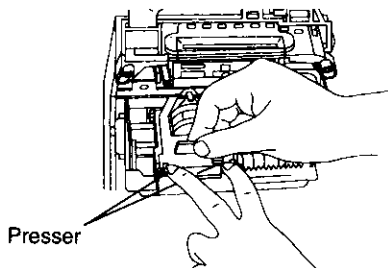

**3** Pull the ribbon cassette presser toward you, remove the ribbon cassette and insert a new one in its place.

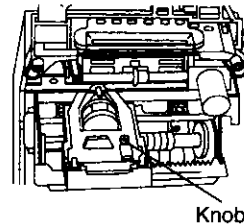

**4** After inserting it, turn the ribbon cassette knob two or three times in direction of arrow to make the ribbon tight.



Note: Be sure to turn the knob clockwise . If turned counterclockwise,  ribbon feeding cannot be done correctly.

# Maintenance

## Adjusting Melody Volume (BX6200, BX6400)

**⚠Warning**

 Do not remove any parts other than those whose removal procedures are described in this operation manual. This could cause fire or electric shock.

Melody volume can be adjusted to suit your environment.

- 1** Remove the upper case.

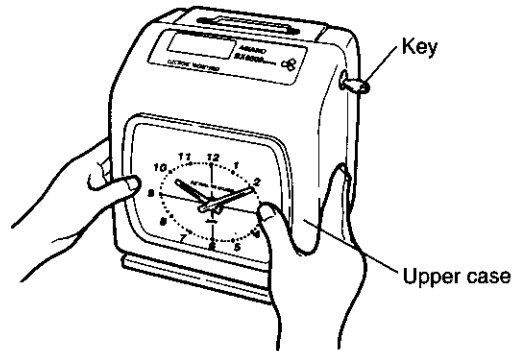

- 2** While a melody is being played, turn the volume adjusting knob with a standard screwdriver to the proper volume. The volume can be adjusted by hand as well.

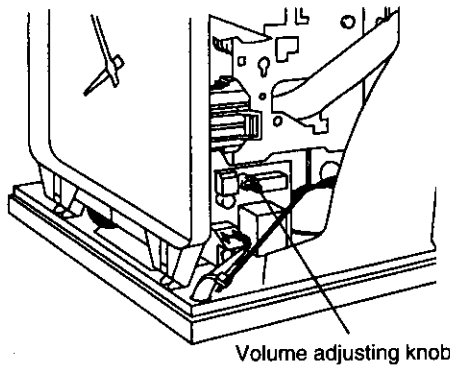

After test setting melody, release the setting and use the time recorder.

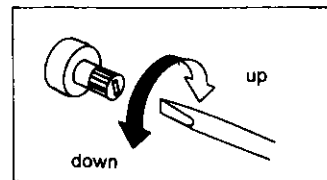

## Daily Maintenance

Clean the case when it becomes soiled.



- Wet a soft cloth with water or a neutral detergent and wipe the case lightly.

**NO!**



- Do not use benzine, volatile thinner or other chemicals for cleaning, because they may damage or discolor the case.

**NO!**

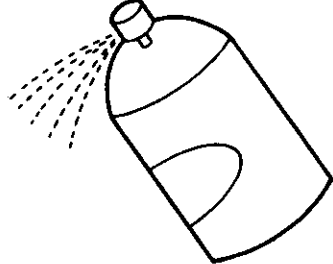

- Note that spraying insecticide over the case may also damage or discolor the case.

Wipe the window glass with a dry soft cloth. Be careful when wiping it because the glass surface has been specially processed.

# APPENDIX

## Specifications

- Power source : 110-120V AC or 220-240V AC +/-10%, 50/60Hz
- Power consumption : BX6000:
  - 110-120V AC standby mode:0.09A, rating:0.40A
  - 220-240V AC standby mode:0.09A, rating:0.22ABX6200/6400:
  - 110-120V AC standby mode:0.13A, rating:0.40A
  - 220-240V AC standby mode:0.09A, rating:0.26A
- Ambient conditions : Temperature -10°C to 45°C (14°F to 114°F)  
Humidity 10% to 90%RH (without dew condensation)
- Dimensions : 222(W) × 236(H) × 162(D)mm
- Weight : 3.2kg
- Clock system : Quartz oscillation system, accuracy +/-3 seconds per week  
(25°C+/-5°C) (77°F+/-10°F)
- Memory holding function : 3 years of total power failure time (all functions other than internal clock stop) with lithium battery.
- Battery backup : When the battery is fully charged (full power reserve), maintains the following :
  - 1) The clock, 2-color selection, time signal, melody, and printing position for up to 72 hours.
  - 2) The printing frequency depends on the working conditions :  
200 printings with 2-color selection and melody for up to 72 hours.  
When the time recorder is operated with full power reserve, the IN/OUT indicator lamp goes on and off.

## Initial Values

Content	Set Value Range	Initial Value
Pay period ending date, Pay period ending day, Current week	01-31, 1-7, 1-2	31 (ending on 31st)
Blank	01-32	01 (1st row)
Day change time	Time 00-23	03 (3 : 00 (midnight))
Print format	<p>① Card Type</p> <p>1 : Monthly pay            2 : Upper step weekly pay (Bottom space : 23mm)            3 : Upper step weekly pay (Bottom space : 35mm)            4 : Lower step weekly pay (Bottom space : 23mm)            5 : Lower step weekly pay (Bottom space : 35mm)            6 : Bi-weekly pay (Bottom space : 23mm)            7 : Bi-weekly pay (Bottom space : 35mm)            8 : One-side monthly pay</p> <p>For BX6400, also available are :</p> <p>0 : Monthly pay surface detection not operational            1 : Monthly pay surface detection operational            9 : One-side monthly pay surface detection operational</p> <p>② Surface Detection Function (BX6000/6200)</p> <p>1 : Operational            2 : Not operational</p> <p>Shifting Print position manually (BX6400)</p> <p>1 : "Shifting print position manually" operational            2 : "Shifting print position manually" not operational</p> <p>③ 24-hour/12-hour Indication Change-over</p> <p>1 : 24-hour indication            2 : 12-hour indication</p> <p>④ Print Format</p> <p>1 : 24 hours (0-23 hours) (0 is not printed at the tens digit of hour. Example : 9 : 00)            2 : 12 hours (AM/PM hours) (Minute is underlined for PM. Example : 9 : <u>00</u>)            3 : 24 hours (0-23 hours) (0 is printed at the tens digit of hour. Example : 09 : 00)</p> <p>⑤ Minute Indication</p> <p>1 : Minutes 2 : 1/100 hour A            3 : 1/100 hour B 4 : 1/10 hour</p> <p>⑥ Day of the week indication</p> <p>0 : Date 1 : English 2 : Spanish            3 : French 4 : German 5 : Italian            6 : Japanese 7 : DAY NO. (1-7)            8 : No indication</p>	<p>1 : Monthly pay</p> <p>2 : not operational</p> <p>1 : 24hour indication</p> <p>1 : 24hours (0-23hours)</p> <p>1 : Minutes</p> <p>0 : Date</p>
Daylight savings time	Daylight savings time starting date Execution time : 0 : 00-9 : 00 Daylight savings time Ending date Execution time : 0 : 00-9 : 00	1996. 1. 1. 2 : 00 1996. 1. 1. 3 : 00
Time Signal duration	0-59	5 (seconds)

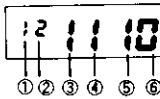

## Weekly Program Setting Table

No.	HR MN	DAY							R/B	SIGNAL	MELODY	PRINTING POSITION
		MO	TU	WE	TH	FR	SA	SU				
1										1234	123456	
2										1234	123456	
3										1234	123456	
4										1234	123456	
5										1234	123456	
6										1234	123456	
7										1234	123456	
8										1234	123456	
9										1234	123456	
10										1234	123456	
11										1234	123456	
12										1234	123456	
13										1234	123456	
14										1234	123456	
15										1234	123456	
16										1234	123456	
17										1234	123456	
18										1234	123456	
19										1234	123456	
20										1234	123456	
21										1234	123456	
22										1234	123456	
23										1234	123456	
24										1234	123456	
25										1234	123456	

- Melody code number
  1. Greensleeves
  2. Home on the Range
  3. Westminster
  4. Two Menuetto