

AMANO[®]

NEW TIME STAMP

NS 5000 series

OPERATION MANUAL



Table of Contents

Preface	1
Before Operation	2
Component Articles	2
Precautions on Installation	2
Powering ON	2
Setting the Side Guide	3
Names and Functions of Parts	4
Dismounting the Top Case	4
Display	5
Setting	7
Preparations for Setting	7
Setting Items	7
Explanation of Terms	7
Setting the Clock	8
Setting the Date	8
Selecting PRINT FORMAT (Print Character)	9
List of Print Formats	10
Selecting NORMAL/REVERSE (Print Character Direction)	17
Setting DATE FORMAT (Character Type)	18
Setting PRINT WIDTH	20
Setting NUMBERING	20
Setting REPEAT (NS5100)	23
Setting COUNT (NS5100)	24
Setting PRINT METHOD	27
D.L.S. setting	28
Adjusting the Print Position	31
Printing	32
Maintenance	33
Errors	33
Daily Maintenance	34
Replacing the Ink Ribbon Cassette	34
Appendix	35
Specifications	35

Preface

Thank you very much for purchasing AMANO New Time Stamp NS5000 Series. The New Time Stamp is a unit that is intended to print dates and numbers on slips and forms. Before using your unit, please read this operation manual thoroughly and keep it at hand so that you may make immediate reference to it when needed.

Cautions!

- ◆ The specifications, external dimensions and other contents described in this manual are subject to change for product improvement without notice.
- ◆ This manual has been carefully prepared. However, if you find any error or unclear description in it, please contact your local AMANO dealer.

List of Models

	NS5000	NS5100
Print format	<input type="radio"/>	<input type="radio"/>
Normal/Reverse	<input type="radio"/>	<input type="radio"/>
Date format	<input type="radio"/>	<input type="radio"/>
Print width	<input type="radio"/>	<input type="radio"/>
Numbering	<input type="radio"/>	<input type="radio"/>
Numbering auto-reset		<input type="radio"/>
Repeat		<input type="radio"/>
Count		<input type="radio"/>
Count auto-reset		<input type="radio"/>
Print method	<input type="radio"/>	<input type="radio"/>
D.L.S.	<input type="radio"/>	<input type="radio"/>

- Regarding DATE FORMAT, the Model NS5000 permits selecting only the year, while the Model NS5100 permits setting a month, a type of zero and a zero suppress function. (Refer to the page "18".)
- The Model NS5100 permits setting 2 optional types of print character pattern (user format 1/user format 2) in addition to 91 patterns of print character.
- A no-break power function is available as a maker option.

Before Operation

Install the New Time Stamp on a stable desk. Before printing, adjust the contents of print and the print position.

- Use the Unit after removing buffer materials.

Component Articles

The New Time Stamp consists of the following component articles:

After unpacking, make sure that all of the following component articles are included in the package.

- New Time Stamp proper 1 unit
- Operation manual 1 copy
- Key 1 set (2 keys)
- Side guide (print position guide) 1 unit

Precautions on Installation

Don't install the Unit in the following environmental conditions:

- Place exposed to direct sunlight or close to a heat source
- Place exposed to rain
- Place that is dusty or receives vibrations
- Place exposed to strong vibrations or shocks

Powering ON

Use a 100/120 V AC or 220/240 V AC for general domestic use as a power supply. Insert the power plug of the New Time Stamp into the 100/120 V AC or 220/240 V AC plug socket.

Even if a power failure occurs, clock data and set data can be protected for 3 years running by means of lithium battery.

However, printing is disabled in the power failure status.

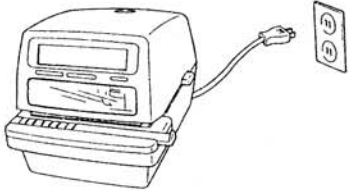

Setting the Side Guide

- Determine the horizontal print position by using the side guide. When positioning is not necessary, set the side guide with its back face upward.
- If the side guide projects too much when it is set, cut it according to the user's desired length.

Fold the back face of the side guide in concave form. After folding it, check the cut end. When the cut end is sharp and dangerous, shave it with a cutter.

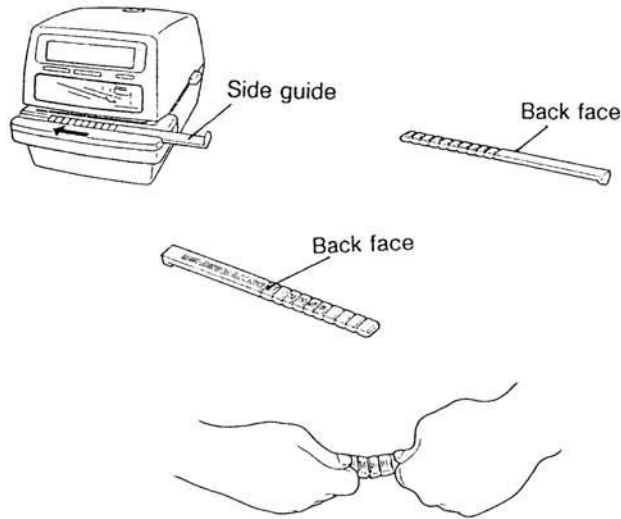

Names and Functions of Parts

Touch plate (right)

In the manual print mode, characters are printed by pressing this portion. When user format 1 and user format 2 are properly used, characters of user format 1 are printed.

Touch plate (left)

In the manual print mode, characters are printed by pressing this portion. When user format 1 and user format 2 are properly used, characters of user format 2 are printed.

Side guide

A print position is determined by guiding the horizontal direction of paper. When horizontal positioning is not necessary, set the side guide with its back face upward.

Display

Usually, the set contents of print including the day of the week, date, time, number etc. are displayed.

Key

Insert the attached key and turn it 90°, and the top case can be dismantled.

Display selector

When print characters are too long, all information cannot be displayed. All the contents of print can be printed by pressing this portion. The 12-hour or 24-hour system of clock display is selected by pressing it continuously for 3 seconds or more.

Print position stopper

This stopper is used to determine a position for inserting paper by moving it forward or backward. After this stopper is set, paper is detected and printing is performed. At initial setting, print can be performed by either of the touch plate or the print position stopper.

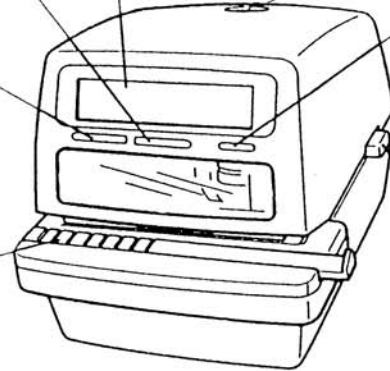

Dismounting the Top Case

[1] Insert the attached key and turn it 90° clockwise.

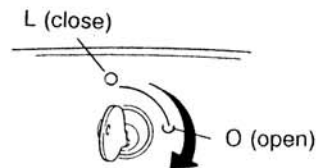

[2] When raising the top case, it can be detached from the main unit.



To mount the top case, place it from above while turning the key clockwise, and fit it to the bottom case. Next, turn the key counterclockwise to lock it.

Display

The normal display depends on the set PRINT FORMAT.

For setting PRINT FORMAT, refer to page 9, and for selecting a print format, refer to page 10.

- When a print format without number is selected:



A digital display showing the date and time. The date is displayed as '95-3-15' and the time as '5:00'. An upward-pointing arrow is positioned above the '3' in the date. The labels 'Julian year', 'Month', 'Day', 'Hour', and 'Minute' are positioned below their respective digits.

Julian year Month Day Hour Minute
(last 2 digits)

- When a print format with a 4-digit number is selected:

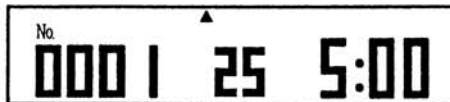

A digital display showing a 4-digit number, day, and time. The number is '0001', the day is '25', and the time is '5:00'. An upward-pointing arrow is positioned above the '1'. The labels 'No.', '4-digits number', 'Day', 'Hour', and 'Minute' are positioned below their respective digits.

No. 4-digits number Day Hour Minute

When a 5-digit number is selected in the user format specification, the same display is provided.

- When a print format with a 4-digit number is selected and REPEAT is used (NS5100 only)

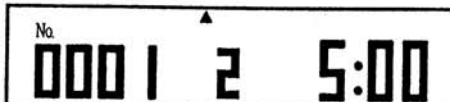

A digital display showing a 4-digit number, repeat count, and time. The number is '0001', the repeat count is '2', and the time is '5:00'. An upward-pointing arrow is positioned above the '2'. The labels 'No.', '4-digit number', 'Repeat', 'Hour', and 'Minute' are positioned below their respective digits.

No. 4-digit number Repeat Hour Minute

When a 5-digit number is selected in the user format specification, the same display is provided.

- When a print format with a 6-digit number is selected:



A digital display showing a 6-digit number and time. The number is '000001' and the time is '5:00'. An upward-pointing arrow is positioned above the '1'. The labels 'No.', '6-digit number', 'Hour', and 'Minute' are positioned below their respective digits.

No. 6-digit number Hour Minute

- Date and Repeat are not displayed.
- When a 7-digit or 8-digit number is selected in the user format specification, the same display is made.

When display selector button "  " is pressed, the display will be selected in the following sequence.

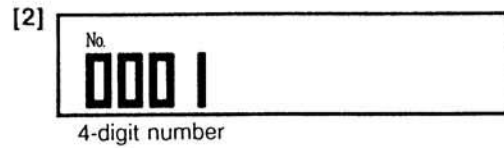

Only when a print format with a number is selected, this is displayed.

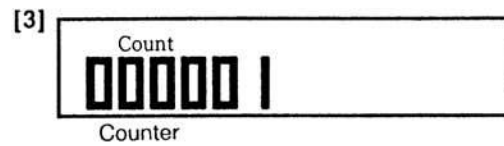

Only when the counter function is used, this is displayed. (NS5100 only)



Only when a print format with a number is selected and REPEAT is set, this is displayed. (NS5100 only)

Setting

Preparations for Setting

Before starting setting, dismount the top case with the key.

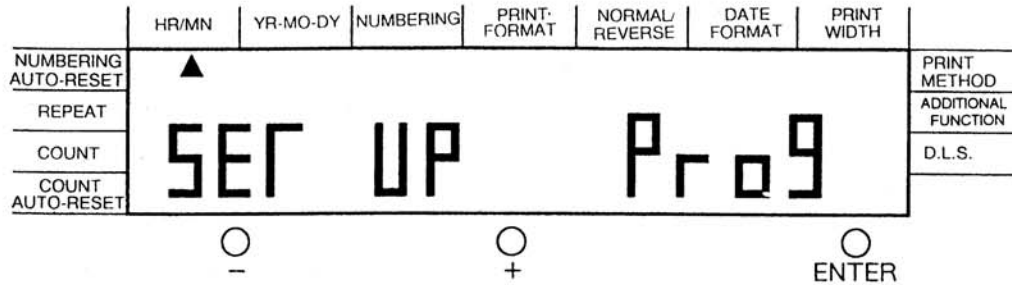

Name	Selecting status	Setting status
"-" button	Selects setting items in sequence. The mark "▲" display moves.	Subtracts a numeric value of the blinking contents of setting, and switches between ON and OFF.
"+" button	Selects setting items in sequence. The mark "▲" display moves.	Adds a numeric value of the blinking contents of setting, and switches between ON and OFF.
ENTER button	Starts the setting selected by moving the mark "▲" display.	Sets the set contents definitively and permits selecting the next setting item.

Setting Items

When using this Unit for the first time, perform setting in the following sequence:

- ① Print format
- ② Normal/Reverse
- ③ Date format
- ④ Print width
- ⑤ Numbering (NS5000)/Numbering auto-reset (NS5100)
- ⑥ Repeat (NS5100)
- ⑦ Count auto-reset (NS5100)/Count (NS5100)
- ⑧ Print method
- ⑨ D.L.S.

Explanation of Terms

- NUMBERING : A function to set a number to be set.
- REPEAT : A function to change a number which has printed several times, over to the next number.
- COUNT : A function to integrate the number of prints internally.

Setting the Clock

Set the clock time to the current time.

Example: To change 9:05 to 13:48

- [1] **Selecting the setting item**
Press the "+" or "-" button to adjust the blinking mark "▲" to HR/MN. Next, press the ENTER button.

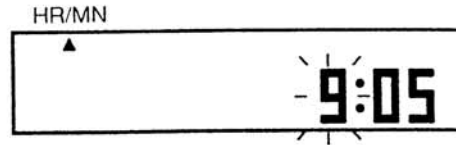

- [2] **Changing "Hour"**
Press the "+" or "-" button to change "Hour" and press the ENTER button to determine it.

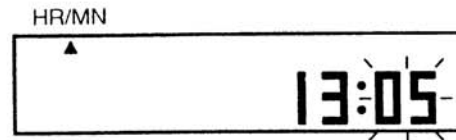

- [3] **Changing "Minute"**
Press the "+" or "-" button to change "Minute".

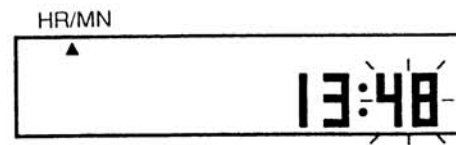

- [4] **Registering the set value**
Press the ENTER button to terminate Hour and Minute setting.
At this time, reset to 0 second.

Setting the Date

Set the date to the current date.

Example: To change January 18, 1995 to February 16, 1995

- [1] **Selecting the setting item**
Press the "+" or "-" button to adjust the blinking mark "▲" to YR-MO-DT. Next, press the ENTER button.



- [2] **Changing "Year"**
Press the "+" or "-" button to change "Year" and then press the ENTER button to determine the set "YEAR".

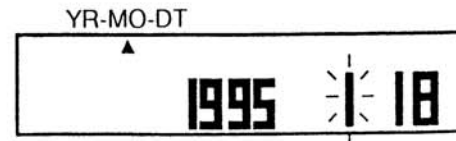

- [3] **Changing "Month"**
Press the "+" or "-" button to change "Month" and then press the ENTER button to determine the set "Month".

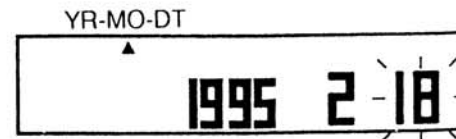

[4] Changing "Day"

Press the "+" or "-" button to change the "Day".

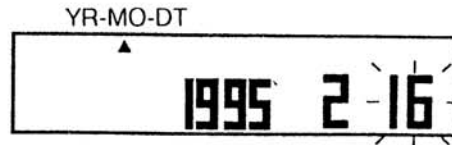

[5] Registering the set value

Press the ENTER button to terminate Year, Month and Day setting.

Selecting PRINT FORMAT (Print Character)

Select a print format to be printed on paper among 91 types.

In the NS5100, one of 92 types is selected.

After PRINT FORMAT is set to "92", a user format will be set.

For what format is to be selected, refer to the "List of Print Formats" on page 10.

Example : To change 10 = Day Month Year Hour Minute (12-hour system, 60-minute advance) to 62 = 6-digit number, Day Month Year Hour Minute (12-hour system, 60-minute advance)

[1] Selecting the setting item

Press the "+" or "-" button to adjust the blinking mark "▲" to PRINT FORMAT.
Next, press the ENTER button.

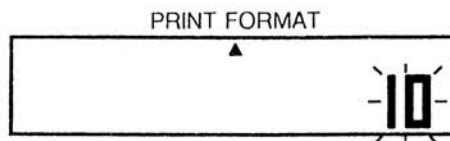

[2] Changing the set value

Press the "+" or "-" button to change the set value.

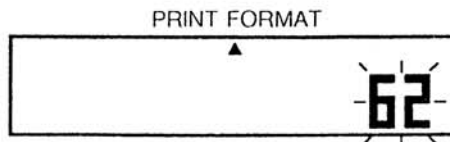

[3] Registering the set format.

Press the ENTER button to complete print format setting.

List of Print Formats

Item No.	Contents of print	Item No.	Contents of print	Item No.	Contents of print
1	YR-MO-DT	32	HR (24H) MN (60) 4-DIGIT NUMBER	63	6-DIGIT NUMBER DT-MO-YR HR (12H) MN (100)
2	DT-MO-YR	33	HR (24H) MN (100) 4-DIGIT NUMBER	64	6-DIGIT NUMBER MO-DT-YR HR (24H) MN (60)
3	MO-DT-YR	34	HR (12H) MN (60) 4-DIGIT NUMBER	65	6-DIGIT NUMBER MO-DT-YR HR (24H) MN (100)
4	YR-MO-DT HR (24H) MN (60)	35	HR (12H) MN (100) 4-DIGIT NUMBER	66	6-DIGIT NUMBER MO-DT-YR HR (12H) MN (60)
5	YR-MO-DT HR (24H) MN (100)	36	6-DIGIT NUMBER HR (24H) MN (60)	67	6-DIGIT NUMBER MO-DT-YR HR (12H) MN (100)
6	YR-MO-DT HR (12H) MN (60)	37	6-DIGIT NUMBER HR (24H) MN (100)	68	YR-MO-DT HR (24H) MN (60) 4-DIGIT NUMBER
7	YR-MO-DT HR (12H) MN (100)	38	6-DIGIT NUMBER HR (12H) MN (60)	69	YR-MO-DT HR (24H) MN (100) 4-DIGIT NUMBER
8	DT-MO-YR HR (24H) MN (60)	39	6-DIGIT NUMBER HR (12H) MN (100)	70	YR-MO-DT HR (12H) MN (60) 4-DIGIT NUMBER
9	DT-MO-YR HR (24H) MN (100)	40	HR (24H) MN (60) 6-DIGIT NUMBER	71	YR-MO-DT HR (12H) MN (100) 4-DIGIT NUMBER
10	DT-MO-YR HR (12H) MN (60)	41	HR (24H) MN (100) 6-DIGIT NUMBER	72	DT-MO-YR HR (24H) MN (60) 4-DIGIT NUMBER
11	DT-MO-YR HR (12H) MN (100)	42	HR (12H) MN (60) 6-DIGIT NUMBER	73	DT-MO-YR HR (24H) MN (100) 4-DIGIT NUMBER
12	MO-DT-YR HR (24H) MN (60)	43	HR (12H) MN (100) 6-DIGIT NUMBER	74	DT-MO-YR HR (12H) MN (60) 4-DIGIT NUMBER
13	MO-DT-YR HR (24H) MN (100)	44	4-DIGIT NUMBER YR-MO-DT HR (24H) MN (60)	75	DT-MO-YR HR (12H) MN (100) 4-DIGIT NUMBER
14	MO-DT-YR (12H) MN (60)	45	4-DIGIT NUMBER YR-MO-DT HR (24H) MN (100)	76	MO-DT-YR HR (24H) MN (60) 4-DIGIT NUMBER
15	MO-DT-YR (12H) MN (100)	46	4-DIGIT NUMBER YR-MO-DT HR (12H) MN (60)	77	MO-DT-YR HR (24H) MN (100) 4-DIGIT NUMBER
16	HR (24H) MN (60)	47	4-DIGIT NUMBER YR-MO-DT HR (12H) MN (100)	78	MO-DT-YR HR (12H) MN (60) 4-DIGIT NUMBER
17	HR (24H) MN (100)	48	4-DIGIT NUMBER DT-MO-YR HR (24H) MN (60)	79	MO-DT-YR HR (12H) MN (100) 4-DIGIT NUMBER
18	HR (12H) MN (60)	49	4-DIGIT NUMBER DT-MO-YR HR (24H) MN (100)	80	YR-MO-DT HR (24H) MN (60) 6-DIGIT NUMBER
19	HR (12H) MN (100)	50	4-DIGIT NUMBER DT-MO-YR HR (12H) MN (60)	81	YR-MO-DT HR (24H) MN (100) 6-DIGIT NUMBER
20	4-DIGIT NUMBER	51	4-DIGIT NUMBER DT-MO-YR HR (12H) MN (100)	82	YR-MO-DT HR (12H) MN (60) 6-DIGIT NUMBER
21	6-DIGIT NUMBER	52	4-DIGIT NUMBER MO-DT-YR HR (24H) MN (60)	83	YR-MO-DT HR (12H) MN (100) 6-DIGIT NUMBER
22	4-DIGIT NUMBER YR-MO-DT	53	4-DIGIT NUMBER MO-DT-YR (24H) MN (100)	84	DT-MO-YR HR (24H) MN (60) 6-DIGIT NUMBER
23	4-DIGIT NUMBER DT-MO-YR	54	4-DIGIT NUMBER MO-DT-YR HR (12H) MN (60)	85	DT-MO-YR HR (24H) MN (100) 6-DIGIT NUMBER
24	4-DIGIT NUMBER MO-DT-YR	55	4-DIGIT NUMBER MO-DT-YR HR (12H) MN (100)	86	DT-MO-YR HR (12H) MN (60) 6-DIGIT NUMBER
25	6-DIGIT NUMBER YR-MO-DT	56	6-DIGIT NUMBER YR-MO-DT HR (24H) MN (60)	87	DT-MO-YR HR (12H) MN (100) 6-DIGIT NUMBER
26	6-DIGIT NUMBER DT-MO-YR	57	6-DIGIT NUMBER YR-MO-DT HR (24H) MN (100)	88	MO-DT-YR HR (24H) MN (60) 6-DIGIT NUMBER
27	6-DIGIT NUMBER MO-DT-YR	58	6-DIGIT NUMBER YR-MO-DT HR (12H) MN (60)	89	MO-DT-YR HR (24H) MN (100) 6-DIGIT NUMBER
28	4-DIGIT NUMBER HR (24H) MN (60)	59	6-DIGIT NUMBER YR-MO-DT HR (12H) MN (100)	90	MO-DT-YR HR (12H) MN (60) 6-DIGIT NUMBER
29	4-DIGIT NUMBER HR (24H) MN (100)	60	6-DIGIT NUMBER DT-MO-YR HR (24H) MN (60)	91	MO-DT-YR HR (12H) MN (100) 6-DIGIT NUMBER
30	4-DIGIT NUMBER HR (12H) MN (60)	61	6-DIGIT NUMBER DT-MO-YR HR (24H) MN (100)		
31	4-DIGIT NUMBER HR (12H) MN (100)	62	6-DIGIT NUMBER DT-MO-YR HR (12H) MN (60)		

● **Setting a User Format (NS5100 only)**

The NS5100 permits setting optional print character patterns other than the 91 print formats. It is possible to set 2 optional print formats. (User format 1/User format 2)
They are set by combining items or characters shown in the following table.

<Table of User Format Items>

	Block code	Block code	Blank character	Half size character					Full size character					D	E	
				0	1	1	2	3	4	5	6	7	8			9
0	Year	Julian date		0	G	W	I	"	0	G	W	a	q	A		
1	Month	Number 4 digits		1	H	X	m	#	1	H	X	b	r	Γ		
2	Day	Number 5 digits		2	l	Y	n	\$	2	I	Y	c	s	Δ		
3	Hour (24H)	Number 6 digits		3	J	Z	o	&	3	J	Z	d	t	⊙		
4	Hour (12H)	Number 7 digits		4	K	SP	p	(4	K	SP	e	u	Λ		
5	Minute (60)	Number 8 digits		5	L	a	q)	5	L	I	f	v	Ξ		
6	Minute (100A)	Repeat		6	M	b	r	*	6	M	Π	g	w	Π		
7	Minute (100B)		SP	7	N	c	s	-	7	N	Π	h	x	Σ		
8	Second		-	8	O	d	t	/	8	O	V	i	y	Φ		
9	Day of the week (numeric)		-	9	P	e	u	,	9	P	X	j	z	Ψ		
A	Day of the week (English)		:	A	Q	f	v	o	A	Q	#	k	Æ			
B	Day of the week (Spanish)		;	B	R	g	w		B	R	\$	l	Å			
C	Day of the week (German)		'	C	S	h	x	j	C	S	ε	m	Ø			
D	Day of the week (Italian)		.	D	T	i	y	"	D	T	¥	n	Ö			
E	Day of the week (Roman)		.	E	U	j	z	°	E	U	&	o	Å			
F	Week No.		,	F	V	k	l	φ	F	V	φ	p	È			

● **How to Read the Table**

Example : Set value 13 = Number 6 digits

* **Minute (100A), Minute (100B)**

1/100 hour A, 1/100 hour B

Minute	0	1	2	3	4	5	6	7	8	9	~	29	30	31	32	33	34	35	~	54	55	56	57	58	59
1/100 hour A	00	02	03	05	07	08	10	12	13	15	~	48	50	52	53	55	57	58	~	90	92	93	95	97	98
1/100 hour B	00	00	00	05	05	05	10	10	10	15	~	45	50	50	50	55	55	55	~	90	90	90	95	95	95

- * Julian date Numbers 1 to 365 are assigned to calendar dates.
1/1 ... 1 12/31 ... 365 (or 366 in a leap year)
- * Repeat When the repeat function is set, the repeat value is printed.
- * SP Represents SPACE.
- * Half size character A
- * Full size character A
- * Double size character .. A

Example : To set user format 1 to "Highlight-specified 6-digit number".

[1] Selecting the setting item

Press the "+" or "-" button to adjust the blinking mark "▲" to PRINT FORMAT. Next, press the ENTER button.

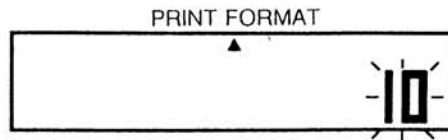

[2] Changing the set value

Press the "+" or "-" button to change the set value into "92" and then press the ENTER button to determine it.

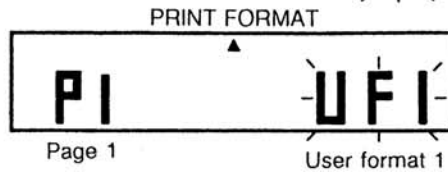
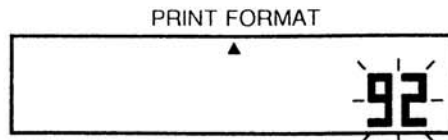

[3] Starting user format 1 setting

Press the ENTER button to start user format 1 setting.

When highlight/double size character is not specified, start with Step ② Selecting print contents.

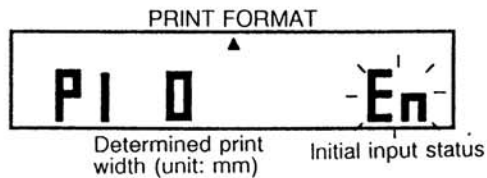

① Selecting a character type (highlight/double size character specification)

Press the "+" or "-" button to set "L = Highlighted style".

The set value changes in the following sequence:

- 00 to 99 → 0A to 0F
- 90 to 99 → 9A to 9F
- A0 to A9 → AA to AF
- E1 to E7 → L → LL
- In → dL → En

Press the ENTER button to determine it.

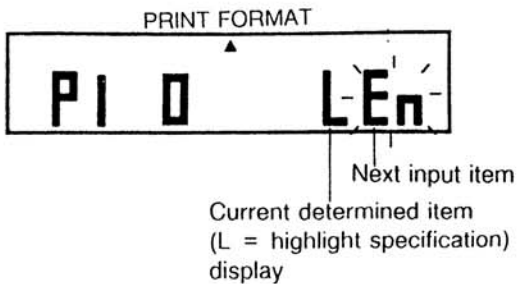
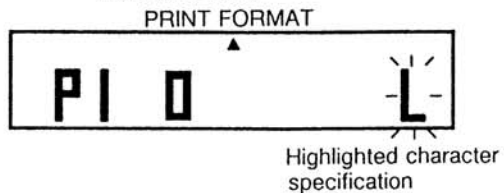

- ② Selecting print contents
Press the "+" or "-" button to set "13 = 6-digit number".

When the "+" key is pressed

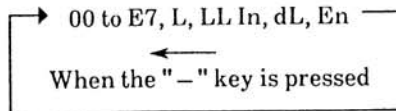

- * For character insertion or deletion, insert the set value 'In' (insert) or 'dL' (delete).

Press the ENTER button to determine it.

- ③ Registering user format 1 setting
Press the ENTER button to register user format 1 setting.

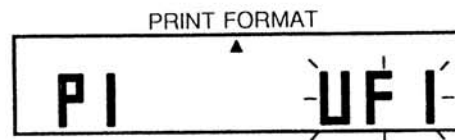
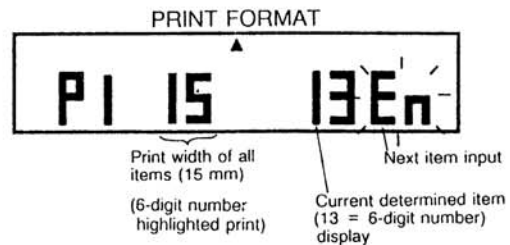
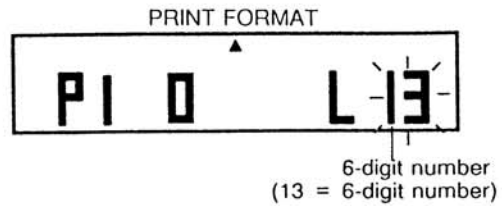

[4] Starting user format 2 setting

Press the "+" button to start user format 2 setting.
Set user format 2 in the same way as user format 1.

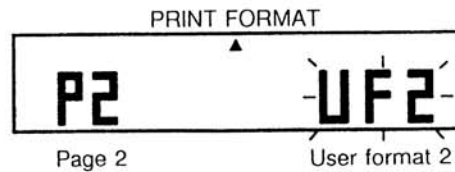

[5] Setting number assignment

Press the "+" button to start number assignment setting.
Set number assignment only when both user format 1 and user format 2 are used.
In the other cases, press the "+" button to proceed to Step 6 "Print Test".

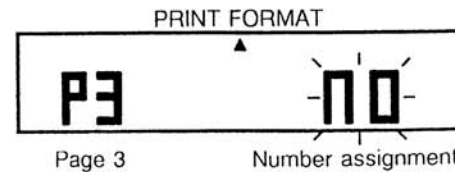

- ① Press the ENTER button.
 oFF : The number is used in common by user format 1 and user format 2.
 on : The number is used separately by user format 1 and user format 2.

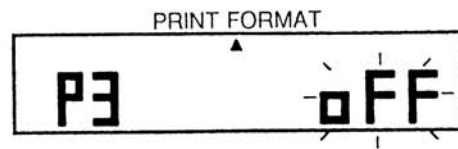

- ② Press the "+" or "-" button to select between oFF and on.
- ③ Press the ENTER button to determine it.

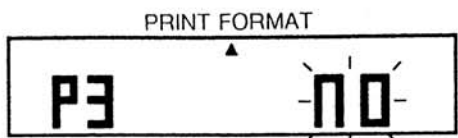
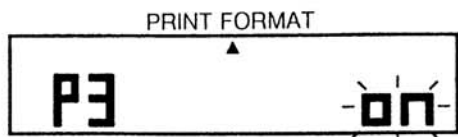

[6] Print test

Press the "+" button to start a print test. This print test is made for the set user format.

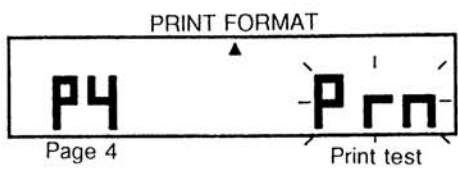

- ① Press the ENTER button.

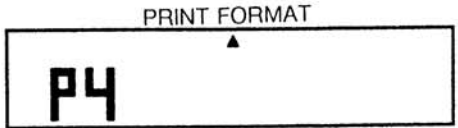

- ② Make a print test.
 Before starting the print test, set paper.

When the "+" button is pressed, user format 1 will be printed.

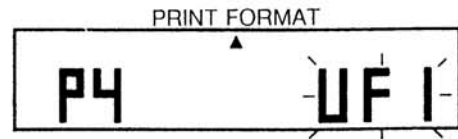

When the "-" button is pressed, user format 2 will be printed.

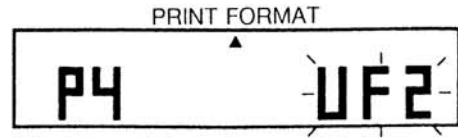

- ③ Press the ENTER button.
 The print test will be terminated and the user format setting screen will be displayed again.

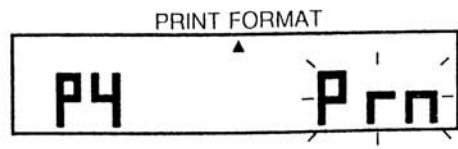

[7] Terminating user format setting

- ① Display the setting end screen.
Press the "+" button to display the user format setting end screen.

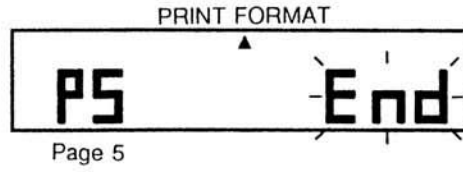

- ② Register the contents of setting.
Press the ENTER button to register the contents of setting.

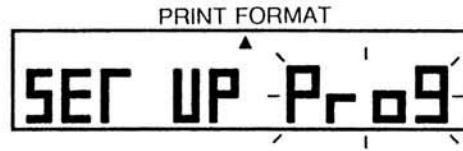

Selecting NORMAL/REVERSE (Print Character Direction)

Whether the paper inserting direction is made equal to the character reading direction or the up-side and the down-side are reversed is selected.

Direction of 12345 = OFF Direction of 54321 = ON

Example : 12345 Printing is performed on the upper side of paper.
(NORMAL/REVERSE = OFF)

[1] Selecting the setting item

Press the "+" or "-" button to adjust the blinking mark "▲" to NORMAL/REVERSE. Next, press the ENTER button.

When user format 1 and user format 2 are set, display each page on the screen.

P1 ... User format 1

P2 ... User format 2

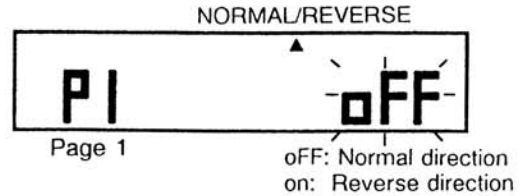

[2] Changing the set value

Press the "+" or "-" button to change the set value.

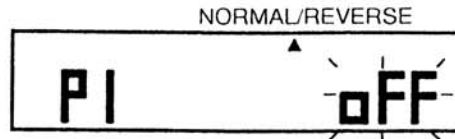

[3] Registering

After changing the set value, press the ENTER button to terminate format direction setting. When user format 1 and user format 2 are set, proceed to the step for setting user format 2 (P2).

Setting DATE FORMAT (Character Type)

How to represent "Year", "Month" and "0" of print characters is selected.

- **Year Selection** (Julian year = OFF, Non-Julian year = ON)

Input value	0	1	2	3	4	5	6	7	8	9	10	..	19	20	..	25	26
Alphabet for Non-Julian year	Non	A	B	C	D	E	F	G	H	I	J	..	S	T	..	Y	Z

- **Month Selection (NS5100 only)**

- 1 = Numeric representation (1, 2, 3, 4, 5, 6, 7, 8, 9, 10, 11, 12)
- 2 = English representation (JAN, FEB, MAR, APR, MAY, JUN, JUL, AUG, SEP, OCT, NOV, DEC)
- 3 = Spanish representation (ENE, FEB, MAR, ABR, MAY, JUN, JUL, AGO, SEP, OCT, NOV, DIC)
- 4 = German representation (JAN, FEB, MAR, APR, MAI, JUN, JUL, AUG, SEP, OKT, NOV, DEZ)
- 5 = French representation (JAN, FEV, MAR, AVR, MAI, JUN, JUL, AOU, SEP, OCT, NOV, DEC)
- 6 = Italian representation (GEN, FEB, MAR, APR, MAG, GIU, LUG, AGO, SET, OTT, NOV, DIC)
- 7 = Roman numeric representation (I, II, III, IV, V, VI, VII, VIII, IX, X, XI, XII)

- **Zero type** Standard "0" = OFF "0" = ON (NS5100 only)

- **Zero suppress function (NS5100 only)**

Execution of zero suppress (_ 1234) = ON

* _ denotes a space and 0 is not printed.

Non-execution of zero suppress (001234) = OFF

Example: *Non-Julian year (HEISEI 7), English representation, standard zero "0", execution of zero suppress*

[1] Selecting the setting item

Press the "+" or "-" button to adjust the blinking mark "▲" to DATE FORMAT.

Next press the ENTER button.



[2] Changing the set value

Year selection (P1)

- Change Julian year/Non-Julian year. Press the "+" or "-" button to select Julian year (ON) or Non-Julian year (OFF). Next, press the ENTER button.
- Specify HEISEI by the initial of the alphabet corresponding to this HEISEI.
 $A = 1$ $B = 2$... $H = 8$... $Z = 26$
 HEISEI = 8
 Check HEISEI. Next, press the ENTER button.
- Check the HEISEI year.
 Next press the ENTER button.

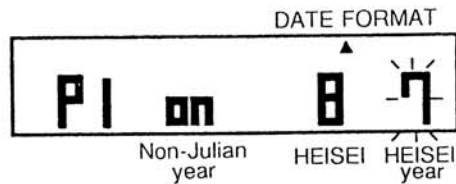
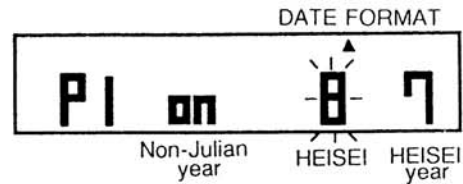
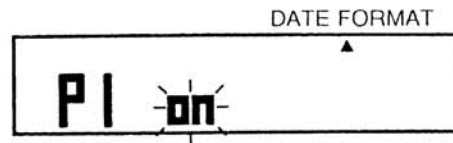

Month Selection (P2) (NS5100 only)

- Change the month type. Press the "+" or "-" button to set 2 (English representation). Next press the ENTER button.

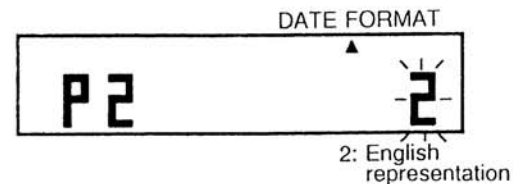

Zero type (P3) (NS5100 only)

- To select the normal representation, check that OFF is displayed. Next, press the ENTER button.

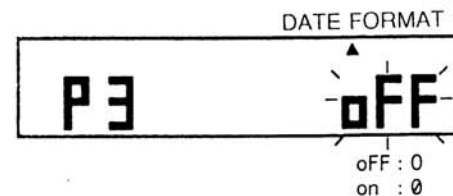

Zero-suppress function (P4) (NS5100 only)

- Change the zero-suppress function. Press the "+" button to display ON.

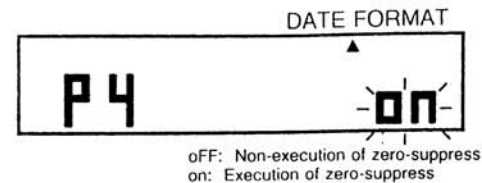

[3] Registering

After changing, press the ENTER button to complete DATE FORMAT setting.

Setting PRINT WIDTH

As the contents of print characters vary depending on each PRINT FORMAT, the whole print width can be adjusted.

The maximum width and the minimum width are fixed. So perform setting to a value close to the desired print width in units of mm.

Note : When the user format of PRINT FORMAT "92" is used, PRINT FORMAT setting is disabled.

Example : To set a print width of 48 mm by using PRINT FORMAT "56"

[1] Selecting the setting item

Press the "+" or "-" button to adjust the blinking mark "▲" to PRINT WIDTH.

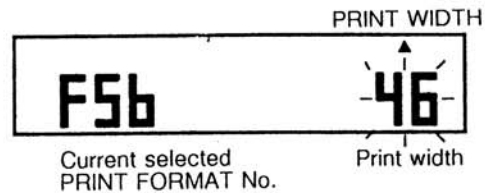

[2] Changing the set value

Press the "+" or "-" button to change the set value.

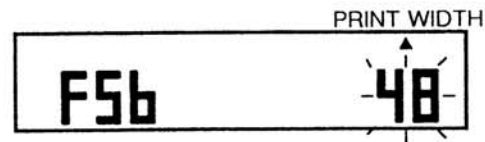

[3] Registering

After changing, press the ENTER button to complete PRINT WIDTH setting.

Setting NUMBERING

Before printing serial numbers, set the first number.

Using the AUTO-RESET function permits a return to the first number at the fixed time every day. (NS5100)

Note : When a format using no number is selected by PRINT FORMAT, numbering setting is disabled.

● Setting numbering

Example : Return to 000001 for use (using 6-digit numbers)

[1] Selecting the setting item

Press the "+" or "-" button to adjust the blinking mark "▲" to NUMBERING.

Next, press the ENTER button.

When both user format 1 and user format 2 use numbers and these numbers are different, display each page on the screen.

P1 ... User format 1 P2 ... User format 2

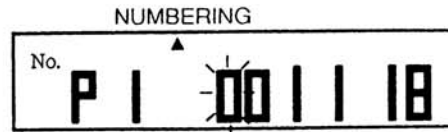

[2] Changing

Start to change the blinking the 6th digit.

Press the "+" or "-" button and then press the ENTER button to determine the set digit. Continue to make changes up to the 1st digit by the same operations.

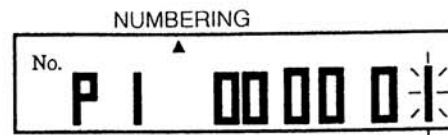

- * When the "+" button and the "-" button are continuously pressed for 3 seconds, the initial value will be registered.

[3] Registering

After changing, press the ENTER button to complete NUMBERING setting.

When both user format 1 and user format 2 use numbers and these numbers are different, proceed to perform user format 2 (P2) setting.

● Setting NUMBERING AUTO-RESET (NS5100)

Example : To return to 000001 at 0:00 every day.

[1] Selecting the setting item

Press the "+" or "-" button to adjust the blinking mark "▲" to NUMBERING

"▲" to NUMBERING

AUTO-RESET.

Next, press the ENTER button.

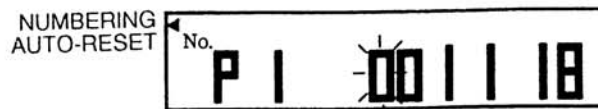

[2] Changing

Numbering initial value

(P1)

- Start to change the blinking 6th digit. Press the "+" or "-" button to adjust it to "0". Next, press the ENTER button.
- Make changes starting with the 5th digit in the same way by the "+" or "-" button. Next, press the ENTER button.

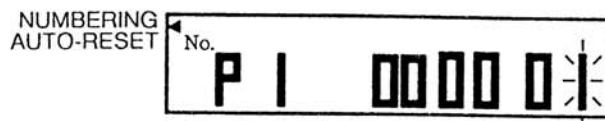
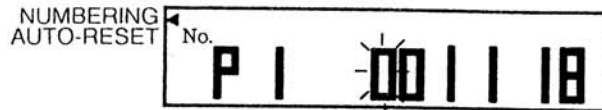

Auto-reset function (P2)

Change the blinking presence/absence of auto-reset. Press the "+" button to adjust it to ON.

Next, press the ENTER button.

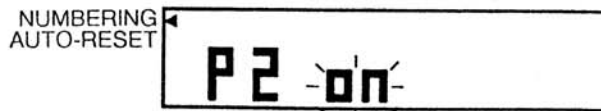
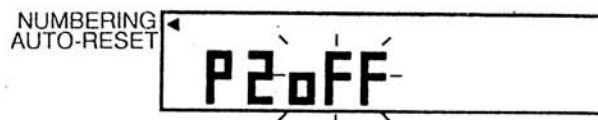

on: Presence of AUTO-RESET
off: Absence of AUTO-RESET

Auto-reset time (hour)

Press the "+" or "-" button to change "HOUR".

Next, press the ENTER button.

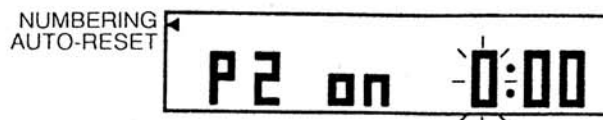

Auto-reset time (minute)

Press the "+" or "-" button to change "MINUTE".

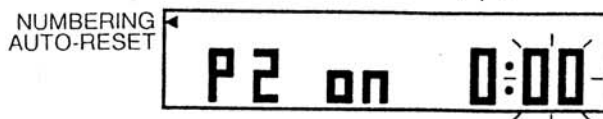

[3] Registering

After changing, press the ENTER button to complete NUMBERING AUTO-RESET setting. When both user format 1 and user format 2 use numbers and these numbers are different, proceed to perform user format 2 (P3 to 4) setting.

Setting REPEAT (NS5100)

After a serial number is printed several times, this function permits changing it to the next number. When REPEAT is set to 1, each serial number changes each time the number is printed once. The maximum setting limit is 9.

Note : When a format using no number is selected by PRINT FORMAT, REPEAT setting is disabled.

Example : To set REPEAT to 3 (1, 1, 1, 2, 2, 2 ...)

[1] Selecting the setting item

Press the "+" or "-" button to adjust the blinking mark "▲" to HR/MN.

Next, press the ENTER button.

When both user format 1 and user format 2 use numbers and these numbers are different, display each page on the screen.

P1 ... User format 1

P2 ... User format 2

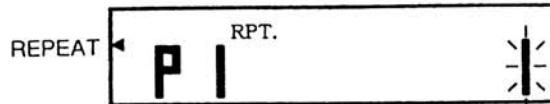

[2] Changing

Change the blinking REPEAT.

Press the "+" button to adjust it to 3.

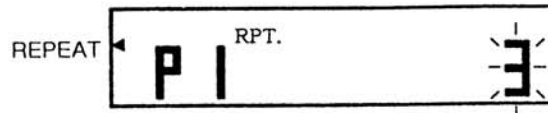

[3] Registering

After changing, press the ENTER button to complete REPEAT setting.

When both user format 1 and user format 2 use numbers and these numbers are different, proceed to perform user format 2 (P2) setting.

Setting COUNT (NS5100)

This function can perform internal integration to check the print count, and also stop the counter value and return it to the first count value at a fixed time every day by means of the auto-reset function. (NS5100)

Note : In the NS5100, when the COUNT of the COUNT AUTO-RESET function is set to "OFF", COUNT setting is disabled. After changing this setting to "UP" or "dn", perform COUNT setting.

● Setting COUNT

Example : To return the counter value to 000000 for use.

[1] Selecting the setting item

Press the "+" or "-" button to adjust the blinking mark "▲" to COUNT. Next, press the ENTER button. When user format 1 and user format 2 are set, display each page on the screen.

P1 ... User format 1

P2 ... User format 2

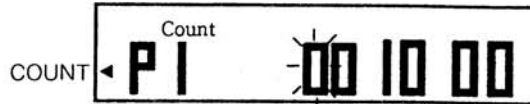

[2] Changing

- Start to change the blinking 6th digit. Press the "+" or "-" button adjust it to "0".
- Make changes starting with the 5th digit in the same way by pressing the "+" or "-" button.

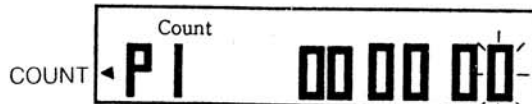

[3] Registering

After changing, press the ENTER button to complete COUNT setting. When user format 1 and user format 2 are set, proceed to perform user format 2 (P2) setting. After completion of COUNT setting, the following will be displayed in the print status.



● COUNT AUTO-RESET setting

Example : To return the counter value to 009999 at 5:00 A.M. every day.

If the counter value becomes all 0 by count-down within the day, the print is stopped.

[1] Selecting the setting item

Press the "+" or "-" button to adjust the blinking mark "▲" to COUNT AUTO-RESET. Next, press the ENTER button.

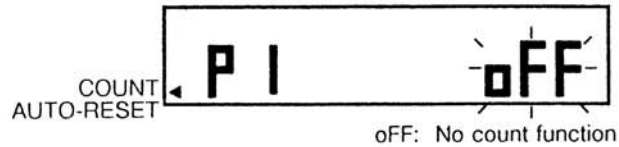

[2] Changing the set value

Count method (P1)

- Change the blinking count method. Press the "+" or "-" button to change the set value.
 OFF ... No COUNT function
 UP ... Addition (1, 2, ..)
 dn ... Subtraction (. 2, 1)
 Next, press the ENTER button.

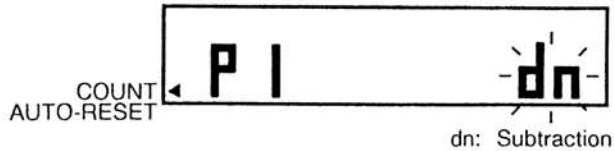

Initial value of COUNT (P2)

- Start to change the blinking 6th digit. Press the "+" or "-" button to change the set value. Next, press the ENTER button.
- Make changes starting with the 5th digit in the same way by the "+" or "-" button.

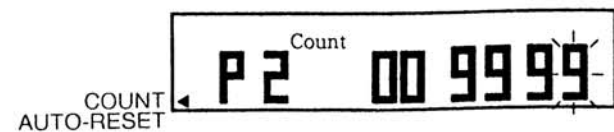
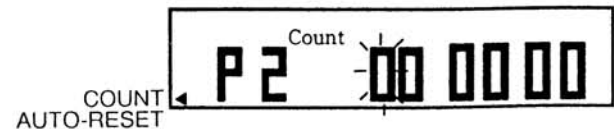

**COUNT AUTO-RESET
(P3)**

AUTO-RESET

- Change the blinking presence/absence of AUTO-RESET.
Press the "+" button to adjust it to "ON".
Next, press the ENTER button.

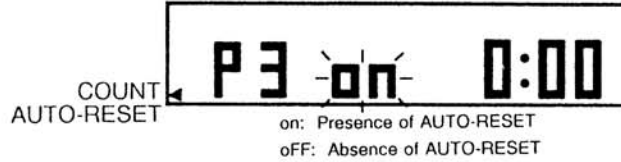

**AUTO-RESET time
(hour)**

- Press the "+" or "-" button to change "HOUR".
Next, press the ENTER button.

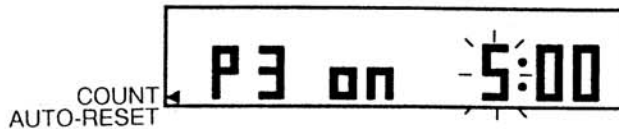

AUTO-RESET (minute)

- Press the "+", or "-" button to change "MINUTE".
Next, press the ENTER button.

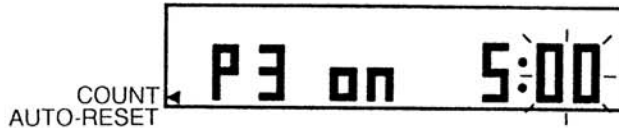

[3] Registering

After changing, press the ENTER button to complete COUNT AUTO-RESET setting.
When both user format 1 and user format 2 are set, process to perform user format 2 (P4 to P6) setting.

Note : In case dn (subtraction) is set to dn, the print function will be automatically stopped when the count value reaches 000000.

For resetting, set the count value again or set the count method to OFF (No count function).

Even in the stop status, the count value will be initialized to make printing possible after the lapse of the reset time.

Setting PRINT METHOD

This function determines which of "Paper detection" and "Touch plate" should be used as a print method.

Note : In the NS5100, when both user format 1 and user format 2 are set, set PRINT METHOD to "1" or "3". If PRINT METHOD is set to "2: Paper detection", it is only possible to print user format 1.

Example : To use only "Paper detection" as PRINT METHOD

[1] Selecting the setting item

Press the "+" or "-" button to adjust the blinking mark "▲" to PRINT METHOD.
Next, press the ENTER button.

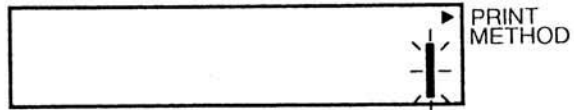

[2] Changing the set value

- Change blinking PRINT METHOD.
 - 1: One of "Paper detection" and "Touch plate"
 - 2: "Paper detection" only
 - 3: "Touch plate" onlyPress the "+" or "-" button to select "2".

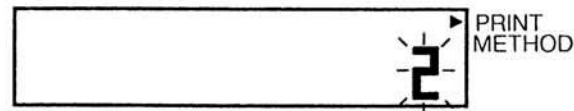

[3] Registering

After changing, press the ENTER button to complete PRINT METHOD setting.

D.L.S. setting

This function permits setting the starting date/ending date of D.L.S. by Month, Date, or Week No. or Day of the Week, and also setting the starting time.

When the starting time/ending time of D.L.S. is set to 2:00, the clock advances to 3:00 when the time reaches 2:00 of the starting day, and returns to 1:00 when the time reaches 2:00 of the ending day.

When the starting month and day is equal to the ending month and day, the D.L.S. cannot function.

When the starting month and starting week No. are equal to the ending month and ending week No., the D.L.S. cannot function, either.

● Entering Month and Date

Example : To set the starting date and time to 5:00 on the 15th of March.

[1] Selecting the setting item

Press the "+" or "-" button to adjust the blinking mark "▲" to D.L.S. Next, press the ENTER button.

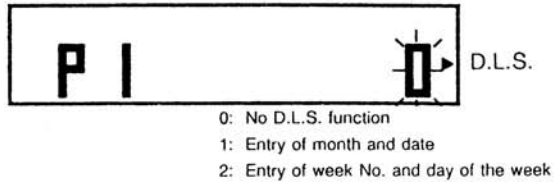

[2] Changing the set value

Selecting a mode (P1)

Press the "+" or "-" button to select "1". Press the ENTER button to determine it.

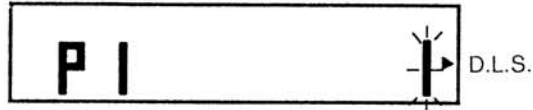

Changing the starting month (P2)

Press the "+" or "-" button to select "3". Press the ENTER button to determine it.



Changing the starting day

Press the "+" or "-" button to select "15". Press the ENTER button to determine it.



Changing the starting time

Press the "+" or "-" button to select "5:00". Press the ENTER button to determine it.



Changing the ending month, date and time (P3)

Proceed to set the ending date of D.L.S. Set it by the same procedure as that for the starting date.

● Entering Week No. and Day of the Week

Example : To set the starting date and time to 5:00 of the 4th Friday of March.

[1] Selecting the setting item

Press the "+" or "-" button to adjust the blinking mark "▲" to D.L.S. Next, press the ENTER button.

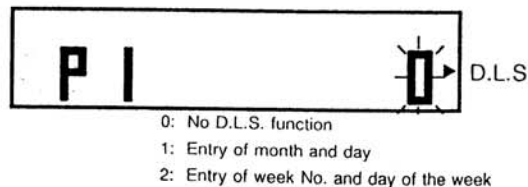

[2] Changing the set value

Selecting a mode (P1)

Press the "+" or "-" button to select "2". Press the ENTER button to determine it.

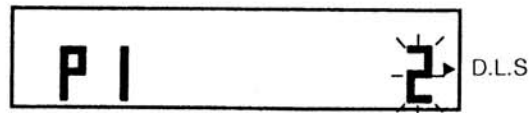

Changing the starting month (P2)

Press the "+" or "-" button to select "3". Press the ENTER button to determine it.

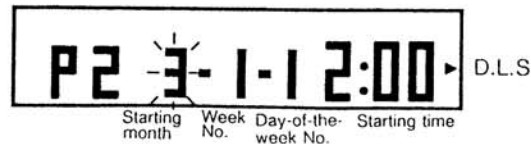

Changing the week No.

Press the "+" or "-" button to select "4". Press the ENTER button to determine it.

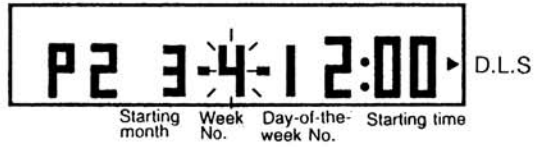

Changing the day-of-the-week No.

Press the "+" or "-" button to select "5".

< Day-of-the-week No. >

- 1: Monday 2: Tuesday
- 3: Wednesday 4: Thursday
- 5: Friday 6: Saturday
- 7: Sunday

Press the ENTER button to determine it.

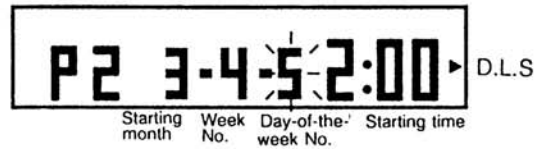

Changing the starting time

Press the "+" or "-" button to select "5:00".

Press the ENTER button to determine it.

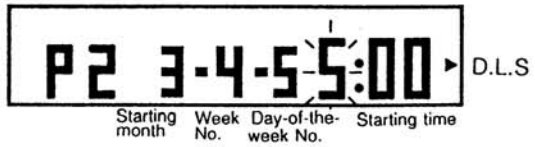

Changing the ending month, day and time (P3)

Proceed to set the ending date of D.L.S. Set the ending date by the same procedure as that for the starting date.

Adjusting the Print Position

Determine a print position on paper.

- [1] Regarding print position (left/right) adjustment, printing can be enabled in the range of 15 to 116 mm, from the end of print paper to the center of print by moving the side guide to the left or right.

The side guide can be inserted from either of the left and the right. The left end and the right end of print paper can be adjusted.

- [2] Regarding print position (depth) adjustment, printing is enabled in the range of 16 to 85 mm from the top end of print paper by moving the print position stopper forward or backward.

Using the print guide film provided under the ribbon guide as a reference, perform print by pressing the touch plate. Then, printing is enabled in the range of 2 to 85 mm from the top end of print paper.

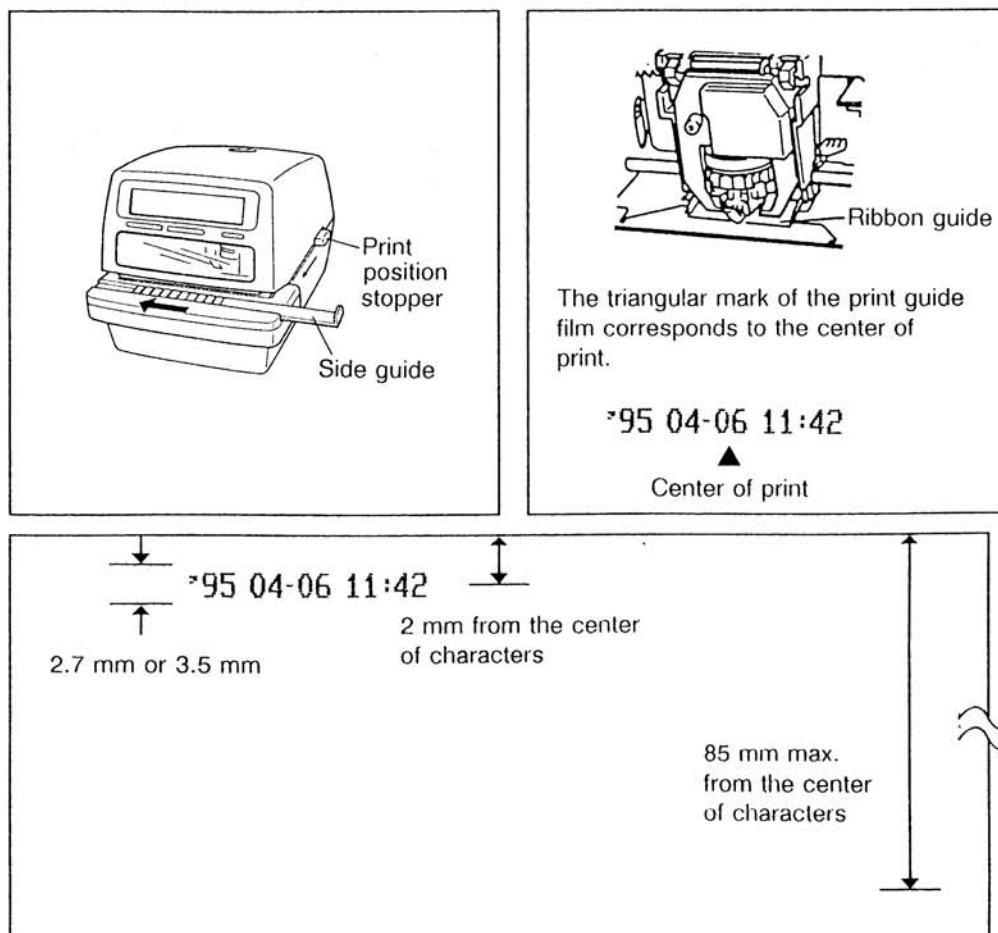

Printing

Perform printing using the orange print guide film visible from the print window as a reference by means of either of "Paper detection" by print position stopper and "Touch plate". (Refer to Adjusting the Print Position on page 31.)

A print method is determined by "Setting PRINT METHOD" on page 27.

■ Printing by "Paper detection" by print position stopper

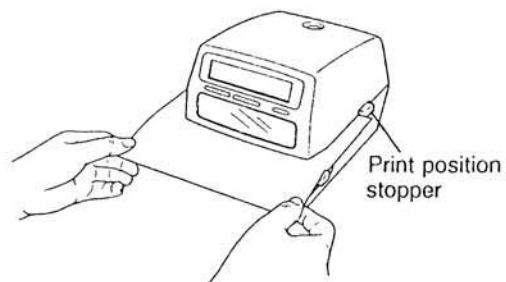

When paper is inserted to the print position stopper, printing will be started.

■ Printing by "Touch plate"

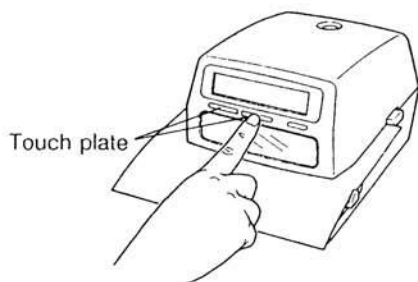

When paper is inserted and then the touch plate is pushed with a finger after making a print position check, printing will be started.

Maintenance

Errors

When an error is displayed, pull out the power cord plug. After the error display disappears, insert the power cord plug into the plug socket. In case a recovery cannot be made from the error status, contact your local AMANO dealer.

Error Table

Error No.	Cause	Corrective measure
01	When printing is started or terminated, the lift position sensor (upper part/lower part) cannot detect the position.	→ Pull out the power cord plug. After the error display disappears, insert the power cord plug into the plug socket.
02	When printing is started, the dot home position cannot be detected or it is impossible to quit from the dot home position.	→ Pull out the power cord plug. After the error display disappears, insert the power cord plug into the plug socket.
03	At the printing time, a dot timing pulse cannot be detected.	→ Pull out the power cord plug. After the error display disappears, insert the power cord plug into the plug socket.
04	At a print return operation, the dot home position cannot be detected.	→ Pull out the power cord plug. After the error display disappears, insert the power cord plug into the plug socket.
05	Program error	→ Pull out the power cord plug. After the error display disappears, insert the power cord plug into the plug socket.
Count End	Counter count-over error (Automatic print stop) The count method of the counter is set to "Subtraction" (dn) and the counter value is 000000.	→ Change the counter setting.

Daily Maintenance

Wipe the New Time Stamp lightly with a soft cloth soaked in water or neutral detergent. Do not use chemicals such as thinner or benzene for cleaning, otherwise they may damage or discolor the case. Also, avoid spraying insecticide on it for the same reason.

Replacing the Ink Ribbon Cassette

When characters are found lightly printed, replace the ribbon cassette.

Note : *Replace the ribbon cassette without turning off the power supply. If the power supply is turned off, it is impossible for you to replace the ribbon cassette.*

[1] Remove the top case.

Remove the top case with the attached key.



[2] Raise the display.

After the top case is removed, the ribbon cassette will automatically move to the center.

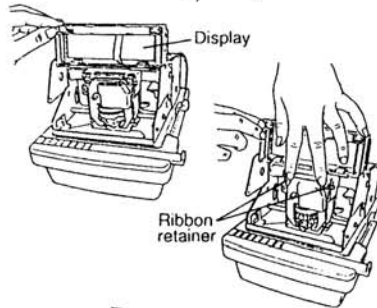

[3] Remove the ribbon cassette.

While releasing the 2 ribbon retainers upward at a time, remove the ribbon cassette.

[4] Set a new ribbon cassette.

Set a new ribbon cassette so that the ribbon may pass between the printer head and the ribbon guide.

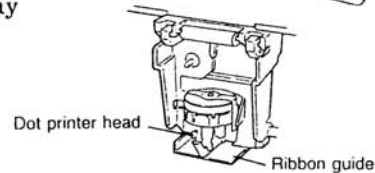

[5] Make sure that the ribbon cassette is properly mounted.

Turn the knob of the ribbon cassette clockwise so that the ribbon may not be slack.

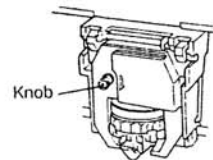

[6] Lower the display and mount the top case.

Note : *While the case is open, printing is disabled.*

[7] Perform trial printing.

Perform printing several times to see if the ribbon cassette has been set correctly.

Appendix

Specifications

Power supply:	100/120 V AC or 220/240 V AC \pm 10% (50/60 Hz)
Power consumption:	Normally 3 W, Max. 12 W
Operating conditions:	Temperature -10°C to 45°C Humidity 10% to 90% (non-condensing)
External dimensions:	170(W) \times 163(H) \times 224(D) mm
Weight:	2.9 kg
Clock system:	Quartz oscillation system, Accuracy \pm 3 seconds per week ($25^{\circ}\text{C} \pm 5^{\circ}\text{C}$)
Characters:	9-pin dot printer system
Printing method:	Manual printing/automatic printing, selectable
No-break power function (maker option):	200 strikes within 72 hours (the same for NS5000 and NS5100)
Memory holding function:	For 3 years for clock and contents of setting
Paper:	Paper thickness 1 mm max. Number of copies Up to 6 sheets (pressure sensitive paper)
Printing range:	Horizontal direction 15 to 116 mm (when the side guide is used) * When the side guide is not used, the printing range is unlimited. Vertical direction 16 to 85 mm (when the paper detection sensor is used), 2 to 85 mm (when the touch plate is used) In any case, the printing range should be equal to the distance from the end of print paper to the center of print.

AMANO®

*Corporate Headquarters
140 Harrison Avenue, Roseland, NJ 07068-1239
(800) 526-2559*

www.amano.com